



saneamientos
GOZALO

TARIFA 2024



saneamientos
GOZALO

www.saneamientosgozalo.com



ALMACÉN Y OFICINAS
Av. Derechos Humanos, 57/59 - 09007 Burgos
T. 947 470 770 - F. 947 470 701
comercial@saneamientosgozalo.com

ALMACÉN P.I. VILLALONQUÉJAR
C/. Condado de Treviño, 22 - 09001 Burgos
T. 947 297 004 - F. 947 470 701
villalonquejar@saneamientosgozalo.com



HORARIO

Lunes a Viernes

Mañanas de 8.00 a 13.30

Tardes de 16.00 a 19.00



saneamientos
GOZALO

www.saneamientosgozalo.com



ALMACÉN Y OFICINAS
Av. Derechos Humanos, 57/59
09007 Burgos
T. 947 470 770 - F. 947 470 701

comercial@saneamientosgozalo.com
Administración: paz@saneamientosgozalo.com
Contabilidad: patricia@saneamientosgozalo.com



HORARIO

Lunes a Viernes

Mañanas de 8.00 a 13.30

Tardes de 15.30 a 18.00



saneamientos
GOZALO

www.saneamientosgozalo.com



ALMACÉN P.I. VILLALONQUÉJAR
C/. Condado de Treviño, 22
09001 Burgos
T. 947 297 004 - F. 947 470 701

villalonquejar@saneamientosgozalo.com
sergio@saneamientosgozalo.com

INDICE DE PRODUCTOS

PAG.

GRUPO

T	Tubería Evacuación Compacta y Estructurada; Serie 2,5 Atm	1
T	Sistema de Evacuación Insonorizada	2
T	Tubería de PVC presión, encolar y junta elástica	3
S	Tubería PVC Saneamiento Teja, PVC Corrugado, PEAD Corrugado, PVC Estructurado	4
T	Tuberías de Fundición Dúctil, Poliéster RFV y PVC Orientado	5
T	Tuberías Polietileno BD PE-40 alimentario y agrícola, PE Alta Densidad PE-100	6
S	Tuberías de Drenaje Barras, Rollos, Rollos c/geotextil	7
O	Tuberías Canalización Eléctrica (TPC), Monotubo, Tritubo, Cuatritubo y Accesorios	7
O	Accesorios PVC Evacuación	8 a 10
O	Accesorios PVC Gran Evacuación Color Teja Junta Elástica, Injertos Saneamiento	11
O	Botes Sifónicos, Calderetas y Sumideros PVC. Sumideros Inox y Fundición ACO	12
O	Válvulas de Esfera PP/PVC, Válvula Antirretorno, Sifón en Línea	13
O	Accesorios PVC Presión	14 a 15
O	Adhesivos PVC y Abrazaderas Tubo	16
O	Accesorios para Tubos de PE en PP, Gama 55 Jimten	17
M	Accesorios para Tubos de PE en Latón, EFFEBI	18
M	Accesorios electrosoldables e inyectados para PE, ELGEF de +GF+	19 y 20
M	Válvulas de Compuerta AVK, Válvulas de Mariposa AVK, Válvula Reductora CLA VAL	21
M	Carretes de Desmontaje, Manguitos anti vibratorios/dilatación	21
M	Accesorios de Fundición Embridados	22
M	Accesorios de Fundición de Junta Mecánica	23
M	Accesorios de Unión y Montaje, Antitracción WAGA y Junta de Goma AVK	24
M	Uniones ARPOL	24
M	Válvulas de Retención, Filtros, Collarines	25
M	Contadores de Agua ELSTER, Válvulas de Acometida con Cerradura, Tornillería	26
9	Válvulas de Esfera ARCO, Retenciones, Filtro de Latón CIM	27
M	Tubería de Acero Negro con Soldadura DIN e ISO, Accesorios de Acero para Soldar	28
M	Accesorio Roscador Latón-Hierro Maleable	29
M	Accesorio Roscador Latón-Hierro Maleable, Tubo Sónico, Obra Civil	30
B	Tubos Multicapa y Racores Press Fitting para Multicapa y PE-X Braseli	31
PB	Tubos y Racores de Polibutileno	32
4	Aislamiento Térmico Coquilla	33
O	Válvulas de Desagüe, Accesorios Saneamiento y Salidas WC JIMTEN	34
O	Sifones Sencillos, Dobles, Válvulas de Desagüe JIMTEN	35
7	Sanitarios GALA, Platos de Ducha	36
O	Canalón y Accesorio de PVC, ADEQUA	37
O	Canalón Metálico y Accesorios	38
9	Bombas WILO, Sumergibles, de Calefacción y Grupos de Presión	39
M	Material para Riego por Aspersión Rain Bird	40
M	Material para Riego por Goteo	41
M	Mangueras y Accesorios	42
M	Registros y Rejillas de Fundición Dúctil. Sumideros de PP	43
M	Marcos y Tapas de Acero Galvanizado y de Acero Inoxidable Estancas	44
M	Geotextiles de PP GEOTEXAN	44
M	Prefabricados de Hormigón. Sistema de Pozos de Registro de PVC ADEQUA	44
M	Accesorios Suelo, Arquetas para Contador, Canales de Hormigón Polímero ACO	45
M	Puertas y Armarios de Contador, Hidrante de Incendios, Boca de Riego y Accesorios	45
9	Fosas Sépticas, Separadores de Hidrocarburos y Separadores de Grasas en PEAD y PRFV	46
9	Depósitos de Gasóleo y Depósitos de Agua Potable en PEAD Sotraltentz	47
	Máquinas y Equipos de Alquiler	48
	Tabla de Equivalencias de Tubos utilizados en Conducciones de Agua	49
	Medidas de las Bridas DIN 2576 PN10, DIN 2502 PN16 y DIN 2503 PN25	49
	Clases de Carga de los Dispositivos de Suelo (Tapas, Rejillas y Canales)	49

GRUPO

T O M PB B 9 4 M 7 S



BUREAU
VERITAS

Bureau Veritas Certification



Certificación

Concedida a

SANEAMIENTOS GOZALO, S.L.

CL CONDADO DE TREVIÑO 22 POL IND VILLALONQUEJAR - 09001 -
BURGOS - ESPAÑA

Bureau Veritas Certification certifica que el Sistema de Gestión ha sido auditado y
encontrado conforme con los requisitos de la norma:

NORMA

ISO 9001:2015

El Sistema de Gestión se aplica a:

**SUMINISTROS DE MATERIALES PARA OBRA CIVIL,
ABASTECIMIENTO, SANEAMIENTO, EDIFICACION E
INDUSTRIA.**

Número del Certificado:	ES119713- 1
Aprobación original:	07-07-2006
Auditoría de certificación/renovación:	26-03-2021
Caducidad de ciclo anterior:	26-06-2021
Certificado en vigor:	27-06-2021
Caducidad del certificado:	26-06-2024

Este certificado está sujeto a los términos y condiciones generales y particulares de los servicios de certificación

Bureau Veritas Iberia S.L.

C/ Valportillo Primera 22-24, Edificio Caoba, 28108 Alcobendas - Madrid, España

ENAC
CERTIFICACIÓN
Nº 04/C-SC004



SERIE "B" Norma UNE EN 1329-1

Ø en m./m.	Espesor en m./m.	L. = 1 m. / €		L. = 3 m. / €	L. = 5 m. / €
		FLEXIBLE	RIGIDO		
20	2,0	1,78	-	-	-
25	2,5	2,13	-	-	-
32	3,0	2,89	1,60	-	7,61
40	3,0	3,73	2,03	-	9,65
50	3,0	5,32	2,57	-	12,26
63	3,0	8,56	-	-	-
75	3,0	18,63	3,93	11,23	18,71
90	3,0	22,52	4,73	13,50	22,52
110	3,2		6,16	17,60	29,78
125	3,2		7,17	20,49	34,16
160	3,2		9,27	26,49	44,17
200	3,9		13,97	39,91	66,50
250	4,9		21,86	62,45	103,98
315	6,2		34,74	99,28	165,46

SERIE "B" estructurado Norma UNE EN 1453

Ø EXTERIOR m./m.	75	90	110	125	160	200	250	315
ESPEJOR m./m.	3,0	3,0	3,2	3,2	3,2	3,9	4,9	6,2
L = 3mts/€	9,96	12,04	15,90	17,42	23,63	33,72	55,73	88,51

SERIE "F" Norma EN 12.200 (sin marca de calidad)

Ø en m./m.	Espesor en m./m.	L. = 1 m. / €	L. = 3 m. / €	L. = 5 m. / €
75	1,8	3,04	8,69	14,82
90	1,8	3,66	10,45	18,20
110	2,2	5,37	15,34	27,05
125	2,5	6,95	19,85	35,13

Evacuación aguas pluviales y frías o conductos de ventilación.

L = Longitud total

TUBERIA PVC RIGIDO SERIE 2,5 KG/cm² (Albañal) unión encolada

Ø EXTERIOR m./m.	110	125	140	160	200	250	315	400	500	
ESPEJOR m./m.	1,7	1,8	1,9	2,0	2,2	2,4	3,2	3,9	5,6	
EUROS METRO	4,06	5,28	6,58	7,50	10,36	14,98	27,55	42,08	78,62	

En esta serie deben tenerse en cuenta los posibles efectos que pueden producir los fenómenos de las cargas del terreno y las depresiones.

Longitud de los tubos = 6 m.l.

SISTEMA DE EVACUACIÓN INSONORIZADA

Certificado AENOR EN 1453-1 (Tubos) y EN 1329 (Accesorios)

Clasificación al Fuego: B-s1, d0, no inflamable

				
Norma UNE - EN 1453				
Ø en mm	Espesor en mm	Longitud	N.º tubos x palet	€/ud.
32	3,0	5	96	25,21
40	3,0	5	80	35,66
50	3,0	5	65	40,51
75	3,0	3	41	37,80
90	3,0	3	29	50,86
110	3,2	3	34	56,50
125	3,2	3	30	79,69
160	3,2	3	17	105,34
200	3,9	3	9	172,21



Codo 87° 30'

32	1,82
40	2,55
50	3,84
75	6,69
90	8,84
110	9,01
125	16,43
160	32,56
200	59,80



Codo 45°

32	1,54
40	2,46
50	3,40
75	5,85
90	7,37
110	7,70
125	12,35
160	23,42
200	47,65



Manguito

32	1,65
40	2,60
50	3,42
75	5,54
90	8,86
110	10,02
125	13,23
160	24,46
200	41,21



Tes 87° 30'

32	3,76
40	5,30
50	6,37
75	11,48
90	16,69
110	17,62
125	25,43
160	54,36
200	99,43



Tes 45°

32	4,36
40	6,58
50	7,91
75	11,48
90	16,69
110	17,62
125	25,43
160	54,36
200	99,43



Ampliación Excéntrica

90-110	11,64
90-125	13,99
110-125	14,23
110-160	22,88
125-160	25,12
125-200	30,82
160-200	38,47

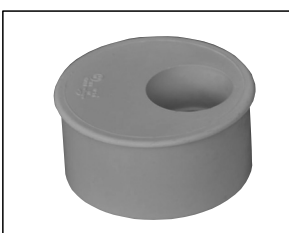

Tapón Reducción

75-40	2,75
90-40	4,15
90-50	4,25
110-40	5,15
110-50	5,25
110-75	5,35
125-40	5,90
125-50	6,05
110-40-32	10,54
110-40-40-40	10,01

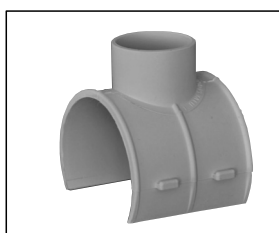

Injerto a Tubo

110/125-40	8,21
110/125-50	8,22

TUBERIA PVC RIGIDO

UNION ENCOLADA

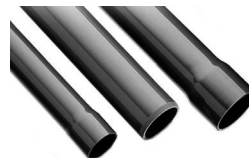

COLOR: Gris RAL 7011

APLICACION: Conducción de agua a presión

Norma UNE EN 1452-2						
Ø exterior en m./m.	6 kg / cm ²		10 kg / cm ²		16 kg / cm ²	
	espesor	€/mts.	espesor	€/mts.	espesor	€/mts.
20	-	-	-	-	1,5	0,97
25	-	-	-	-	1,9	1,47
32	-	-	-	-	2,4	2,02
40	-	-	1,9	1,93	3	2,76
*50	2,0	2,43	2,4	2,90	3,7	4,25
*63	2,0	3,81	3	4,43	4,7	6,69
75	2,2	4,21	3,6	6,33	5,6	9,46
90	2,7	5,96	4,3	9,04	6,7	13,55
110	2,7	7,22	4,2	11,06	6,6	16,72
125	3,1	9,46	4,8	14,25	7,4	-
140	3,5	11,93	5,4	18,03	8,3	-
160	4	15,34	6,2	23,52	9,5	-
180	4,4	19,15	6,9	29,34	10,7	-
200	4,9	23,41	7,7	36,26	11,9	-
250	6,2	37,10	9,6	-	14,8	-
315	7,7	57,57	12,1	-	18,7	-
400	9,8	93,46	15,3	-	23,7	-
500	12,3	-	19,1	-	29,7	-
630	15,4	-	24,1	-	-	-

Longitud total estándar: 5 mts. hasta Ø 63. PN= Presión nominal expresada en Bar. (*) consultar precio y plazo
6 mts. desde Ø 75. 1 bar= 10 N/mm² = 0,1 MPa

*El precio de la tubería 50/6 y 63/6 corresponde a la tubería 50/8 y 63/8

TUBERIA PVC RIGIDO

UNION JUNTA ELASTICA



COLOR: Gris RAL 7011

APLICACION: Conducción de agua a presión

Norma UNE EN 1452-2						
Ø exterior en m./m.	6 kg / cm ²		10 kg / cm ²		16 kg / cm ²	
	espesor	€/mts.	espesor	€/mts.	espesor	€/mts.
*63	2,4	3,77	3	4,37	4,7	6,61
75	2,2	4,14	3,6	6,22	5,6	9,30
90	2,7	5,88	4,3	8,82	6,7	13,24
110	2,7	7,11	4,2	10,78	6,6	16,35
125	3,1	9,27	4,8	13,83	7,4	-
140	3,5	11,68	5,4	17,50	8,3	-
160	4	14,98	6,2	22,79	9,5	-
180	4,4	18,90	6,9	28,64	10,7	-
200	4,9	22,93	7,7	35,22	11,9	-
250	6,2	36,26	9,6	-	14,8	-
315	7,7	56,34	12,1	-	18,7	-
400	9,8	90,95	15,3	-	23,7	-
500	12,3	143,67	19,1	-	29,7	-
630	15,4	225,90	24,1	-	-	-

Longitud total estándar: 6 mts.

Estos precios incluyen el aro de caucho correspondiente.

(*) consultar precio y plazo

*El precio de la tubería 50/6 y 63/6 corresponde a la tubería 50/8 y 63/8

TUBERIAS SANEAMIENTO PVC

JUNTA ELASTICA. COLOR TEJA



COLOR TEJA Norma UNE EN 1401-1					UNE 1452 PN-6	
Longitud total L = 6.000 m./m.					Saneamiento c/presión	
Ø exterior en m./m.	SN2 RCE > 2 KN/M2		SN4 RCE > 4 KN/M2		SN4 RCE > 4 KN/M2	
	espesor	€/metro lineal	espesor	€/metro lineal	espesor	€/metro lineal
110	-	-	-	-	3,2	5,96
125	-	-	-	-	3,2	7,79
160	3,2	8,84	4,0	9,42	4,0	12,23
200	3,9	13,33	4,9	14,41	4,9	18,70
250	4,9	20,88	6,2	22,86	6,2	26,93
315	6,2	32,80	7,7	34,94	7,7	45,47
400	7,9	53,59	9,8	57,18	9,8	74,14
500	9,8	85,49	12,3	92,95	12,3	118,36
630	12,3	134,07	15,4	143,35	15,4	190,63
710	13,9	-	17,4	-	17,4	-
800	15,7	-	19,6	-	19,6	-

Tubo de longitud 6 metros con junta incluida.

TUBERIA PVC CORRUGADA TEJA

PARA SANEAMIENTO SN-8 EN 13476-1

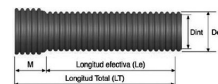

Ø EXTERIOR	160	200	250	315	400	500	630	800	1000	1200
Ø INTERIOR	146,00	182,00	227,50	285,20	364,00	451,80	590,00	775,00	970,00	1102,90
€/metro	12,61	18,72	28,82	40,06	60,02	131,78	213,91	354,33	519,02	713,48

Doble pared. Interior Liso. Gran resistencia al aplastamiento.
Longitud Standard 6 metros. RCE > 8 kn/m2

TUBERIA PVC ESTRUCTURADA LISA

PARA SANEAMIENTO EN 13476-1

Ø	110	125	160	200	250	315	400	500	630
SN 4 Espesor	3,2	3,2	4,0	4,9	6,2	7,7	9,8	12,3	15,4
€/metro	5,17	5,94	9,00	12,89	21,41	32,54	52,54	83,34	138,27
SN 8 Espesor	3,4	3,9	5,0	6,3	7,8	9,8	12,5	15,6	19,7
€/metro	5,50	7,22	11,11	16,50	29,52	44,73	72,34	114,51	195,62

Tubería estructurada, interior y exterior liso. Unión por junta elástica.
Longitud Standard 6 metros. Color Teja.

TUBERIA PE AD CORRUGADA

PARA SANEAMIENTO SN-8 EN 13476-1

Ø EXTERIOR en m./m.	Ø INTERIOR en m./m.	€/metro NEGRO
160	136	5,28
200	172	6,84
250	213	10,89
315	265	15,60
350	300	17,86
400	342	25,46
465	400	28,97
500	426	38,48
580	500	48,75
630	541	56,30
700	600	70,09
800	685	98,69
1.000	858	162,87
1.200	1.036	253,00

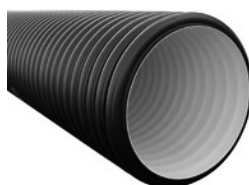

Longitud	Ø
6 m.	160 - 580
6,10 m.	630 - 1.000
6,25 m.	1.200

L = 6 m.l. - Unión por boquilla y junta elástica
Resistencia al aplastamiento:
RCE > 8 Kn/m2



JUNTA ACOMETIDA

PARA TUBO CORRUGADO

Ø	315-160	315-200	400-160	500/400-200
€/unidad	35,60	41,20	43,50	44,78

TUBERIA DE FUNDICION



Saint-Gobain Pur	Tubería de Fundición Dúctil C40-C30, recubrimiento interior de poliuretano. Revestimiento exterior Zinc Aluminio										
DN	80	100	125	150	200	250	300	350	400	500	600
€/metro	-	108,10	-	111,20	135,50	186,60	214,30	280,70	320,60	421,70	525,30
Saint-Gobain Natural	Tubería de Fundición revestida interiormente de mortero de cemento Clase C40-C30										
DN	80	100	125	150	200	250	300	350	400	500	600
€/metro	45,92	56,78	69,48	73,98	101,85	129,14	170,75	218,56	256,36	348,88	467,88

TUBERIA POLIESTER REFORZADO CON FIBRA DE VIDRIO (PRFV)

DN (M/M)	SN (N/m2)	PN (Atm)	Ln (long. Standard)
de 100 m/m	2.500	1 - 16	6
	5.000	6 - 20	
a 3.500 m/m	10.000	10 - 25	12



TUBERIA PVC ORIENTADO PVC-O UNION JUNTA ELASTICA



COLOR: Azul RAL 5015

APLICACION: Conducción de agua a presión

Norma UNE ISO 16422 : 2008						
Ø exterior en m./m.	12,5 kg / cm2		16kg / cm2		25 kg / cm2	
	espesor	€/mts.	espesor	€/mts.	espesor	€/mts.
90	-	-	2,0	11,20	3,1	19,64
110	2,0	12,91	2,4	13,77	3,8	22,84
125	2,2	15,61	2,8	16,63	4,3	27,07
140	2,5	18,38	3,1	19,42	4,8	32,45
160	2,8	22,95	3,5	24,43	5,5	40,55
200	3,5	34,47	4,4	37,06	6,9	61,43
225	4,0	44,91	5,0	48,33	7,7	79,87
250	4,4	53,33	5,5	57,37	8,6	90,95
315	5,5	84,87	6,9	90,81	10,8	132,70
400	7,0	136,48	8,8	146,86	13,7	216,29
500	8,8	214,24	11,0	234,16	17,1	331,78
630	11,0	336,31	13,8	358,00	21,6	535,77

Longitud total estándar: 6 mts.

Estos precios incluyen el aro de caucho correspondiente.

TUBERIA POLIETILENO

NORMA: EN 12.200

COLOR: Negro banda azul

Apto para uso Alimentario/Agrícola

BAJA DENSIDAD (PE-40)



6 ATMOSFERAS					10 ATMOSFERAS				
Ø exterior en m./m.	Espesor pared	Peso kg/m.m.	€/metro		Ø exterior en m./m.	Espesor pared	Peso kg/m.m.	€/metro	
			Alimentario	Agrícola				Alimentario	Agrícola
20	2,0	0,115	1,04	0,44	20	3,0	0,151	1,46	0,60
25	2,3	0,168	1,52	0,63	25	3,5	0,236	2,15	0,89
32	3	0,266	2,47	1,00	32	4,4	0,379	3,44	1,46
40	3,7	0,422	3,82	1,62	40	5,5	0,589	5,36	2,27
50	4,6	0,653	5,91	2,50	50	6,9	0,918	8,34	3,54
63	5,8	1,031	9,37	3,87	63	8,6	1,442	13,12	5,55
75	6,8	1,438	13,07	5,55	75	10,3	2,053	18,71	7,94
90	8,2	2,08	18,93	8,02	90	12,3	2,94	26,78	11,33

TUBERIA POLIETILENO

NORMA: UNE 12.2015

COLOR: Negro con banda azul

APLICACION: Conducción de agua a presión

ALTA DENSIDAD (PE-100)

Uso Alimentario



6 ATMOSFERAS			10 ATMOSFERAS			16 ATMOSFERAS		
Ø exterior en m./m.	Espesor pared	€/metro	Ø exterior en m./m.	Espesor pared	€/metro	Ø exterior en m./m.	Espesor pared	€/metro
20	-	-	20	-	-	20	2,0	0,64
25	-	-	25	-	-	25	2,3	0,92
32	-	-	32	2,3	1,04	32	2,9	1,49
40	-	-	40	2,4	1,53	40	3,7	2,25
50	-	-	50	3,0	2,36	50	4,6	3,48
63	-	-	63	3,8	3,76	63	5,8	5,51
75	-	-	75	4,5	5,31	75	6,8	7,70
90	-	-	90	5,4	7,64	90	8,2	11,15
110	4,2	7,31	110	6,6	11,45	110	10,0	16,44
125	4,8	9,80	125	7,4	14,63	125	11,4	21,60
140	5,4	12,42	140	8,3	18,44	140	12,7	27,00
160	6,2	16,20	160	9,5	24,00	160	14,6	35,34
180	6,9	20,68	180	10,7	30,43	180	16,4	44,74
200	7,7	25,03	200	11,9	37,45	200	18,2	55,05
225	8,6	-	225	13,4	-	225	20,5	-
250	9,6	38,99	250	14,8	58,24	250	22,7	85,75
280	10,7	-	280	16,6	-	280	25,4	-
315	12,1	61,83	315	18,7	106,79	315	28,6	135,97
335	13,6	-	335	21,1	-	335	32,3	-
400	15,3	99,20	400	23,7	148,93	400	36,4	221,27
450	17,2	-	450	26,7	-	450	41,0	-
500	19,1	157,98	500	29,6	-	500	45,5	-
630	24,4	-	630	37,1	-	630	57,3	-
710	27,2	-	710	41,8	-	710	-	-
800	30,6	-	800	47,1	-	800	-	-
900	34,4	-	900	53,3	-	900	-	-
1000	38,5	-	1000	58,9	-	1000	-	-
1200	46,2	-	1200	-	-	1200	-	-
1400	46,2	-	1400	-	-	1400	-	-
1600	46,2	-	1600	-	-	1600	-	-

SUMINISTROS: Rollos de 100 m. para los diámetros de 20, 25, 32, 40, 50, 63, 75 y 90 mm.

Rollos de 50 m. para los diámetros de 110 m.

Barras de 6 para los diámetros de 40 a 400 mm.

Barras de 12 m. para los diámetros de 75 a 200 mm.

Barras de 13 m. para los diámetros de 250 mm. en adelante

* CONSULTAR

TUBERIA DE DRENAJE

CORRUGADA BARRAS

DN	110	160	200	250	315	400	500
€/metro	2,48	4,46	6,45	16,58	23,90	38,72	74,49

Longitud Standard: 6 mts. PE AD doble pared. Perforación Estandar: 270°



CORRUGADA ROLLOS

Ø	90	110	125	160	200
Mts/rollo	50	50	50	50	25
€/metro	-	2,27	3,11	4,19	5,89

Rollos de 50 mts. con manguito hasta Ø 160 excepto Ø 200 rollos de 25 mts.

Corrugado exterior, liso interior. Perforación: 360°

Material: Polietileno AD.



DRENAJE CON GEOTEXTIL

Rollos 50 ml.	80	100
Dren monocapa PE AD	2,11	2,48

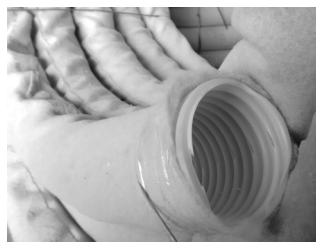

TUBO FLEXIBLE - TPC

CORRUGADO PARA CANALIZACION ELECTRICA.
DOBLE PARED. NORMA EN 50086 NI 52.95.03 TPC



Ø	40	50	63	75	90	110	125	160	200
L-ROLLOS (250 Nw.)	-	-	1,00	-	1,51	2,03	2,86	3,92	5,35
N-ROLLOS (450 Nw.)	0,89	1,03	1,27	1,70	1,81	2,35	3,13	4,05	5,67
L-BARRAS (250 Nw.)	-	-	-	-	-	2,35	3,13	4,05	5,67
N-BARRAS (450 Nw.)	2,35	-	-	-	-	-	-	4,05	5,67

Barras de 6 metros con manguito.

Rollos de 50 metros con manguito hasta Ø 160 excepto Ø 200 rollos de 25 mts.

Corrugado exterior, liso interior.

Material: Polietileno AD.

MANGUITO TPC

Ø	€/uds
40	1,51
50	2,16
63	2,50
75	2,92
90	3,08
110	3,98
125	5,26
160	8,90
200	11,17



SEPARADORES

Ø	€/uds
63/4	0,42
110/4	0,57
160/4	1,10
200/4	3,90

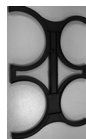

TAPONES

Ø	€/uds
63	1,10
110	1,90
160	2,60

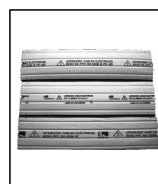

Placa señalización

PE-HD
anónima e Iberdrola

Medida	€/ud.
1000 x 250	1,58



Banda de señalización

Agua, electricidad,
obras y teleco

Medida	€/rollo
15 cm. x 500	67,50

TUBERIA DE PE AD MONOTUBO, TRITUBO Y CUATRITUBO



Ø	40	50
Monotubo	1,38	1,73
Tritubo	4,28	5,56
Cuatritubo	10,20	-

ACCESORIOS PVC EVACUACION



CODOS HEMBRA-HEMBRA

UNION ENCOLADA



45°

Ø Diámetro	€/ud.
32	0,38
40	0,45
50	0,76
110	10,51
125	11,98



67° 30'

Ø Diámetro	€/ud.
32	0,64
40	0,65
50	2,03



87° 30'

Ø Diámetro	€/ud.
32	0,37
40	0,38
50	0,96
110	4,91
125	10,06

CODOS MACHO-HEMBRA

UNION ENCOLADA



45°

Ø Diámetro	€/ud.
32	0,55
40	0,65
50	1,67
75	2,25
90	1,95
110	2,16
125	3,19
160	6,39
200	16,93
250	27,54
315	109,11



67° 30'

Ø Diámetro	€/ud.
32	1,99
40	2,09
50	2,19
75	2,39
90	3,15
110	3,47
125	5,42
160	16,75
200	54,28



87° 30'

Ø Diámetro	€/ud.
32	0,72
40	0,76
50	1,65
75	1,82
90	1,91
110	1,96
125	4,05
160	7,97
200	25,10
250	46,35
315	144,68

DEFLECTOR DE VENTILACION

PVC UNION ENCOLADA



Ø Diámetro	€/ud.
75	22,55
90	26,41
110	32,98
125	36,03
160	54,83

INJERTOS SIMPLES HEMBRA-HEMBRA

UNION ENCOLADA

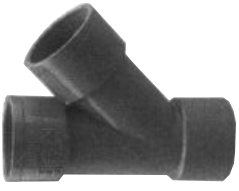

45°	
Ø Diámetro	€/ud.
32	0,85
40	0,96
50	3,54



67° 30'	
Ø Diámetro	€/ud.
32	0,98
40	1,90
50	3,47



87° 30'	
Ø Diámetro	€/ud.
32	0,88
40	0,96
50	2,58

INJERTOS SIMPLES MACHO-HEMBRA

UNION ENCOLADA



45°	
Ø Diámetro	€/ud.
32	2,54
40	2,75
50	3,91
75	4,10
90	4,20
110	4,29
125	7,69
160	16,31
200	42,54
250	80,89
315	214,03



67° 30'	
Ø Diámetro	€/ud.
32	3,15
40	3,78
50	4,57
75	6,56
90	8,00
110	8,82
125	13,08
160	35,05



87° 30'	
Ø Diámetro	€/ud.
32	1,89
40	2,09
50	2,19
75	3,35
90	3,50
110	3,61
125	6,15
160	11,06
200	43,74
250	116,36
315	227,39

INJERTOS A TUBO CLIP



Ø Diámetro	€/ud.
90/40	2,15
90/50	2,17
110/40	2,17
110/50	2,17
125/40	3,44
125/50	3,99
125/110	8,74
160/50	2,34
160/110	8,74
160/125	8,74

MANGUITOS/TAPONES/REDUCCIONES

UNION ENCOLADA

Reducción Simple



Ø Diámetro	€/ud.
40/32	0,61
50/40	0,88
75/40	1,51
75/50	1,51
90/40	1,98
90/50	1,98
110/40	2,32
110/50	2,33
125/40	3,02
125/50	3,02

Reducción Doble



Ø Diámetro	€/ud.
90/40/32	1,92
90/40/40	1,97
110/50/40	2,29
110/40/40	2,39
125/40/40	3,02
125/50/40	3,32
125/50/50	3,32

Reducción Triple



Ø Diámetro	€/ud.
110/40/40/40	2,30
110/50/40/40	2,26

Tapón Registro



Ø Diámetro	€/ud.
32	1,06
40	1,32
50	1,59
75	2,16
90	3,13
110	4,27
125	4,95
160	14,67
200	26,21
250	60,34
315	223,55

Tapón Reducción

Ø Diámetro	€/ud.
90/75	2,32
110/90	3,91
125/110	4,42
160/110	8,13
160/125	8,43
200/160	15,98

Manguito H - H



Ø Diámetro	€/ud.
32	0,49
40	0,52
50	0,93
75	1,85
90	1,88
110	2,03
125	4,29
160	6,90
200	18,03
250	52,05
315	79,83

Reducción Excéntrica



Ø Diámetro	€/ud.
90/75	2,32
110/75	2,52
110/90	2,59
125/75	2,45
125/90	3,25
125/110	2,45
160/110	5,44
160/125	5,73
200/160	15,06
250/200	43,71
315/250	107,91

Reducción Concéntrica



Ø Diámetro	€/ud.
90/75	3,87
110/90	3,87
125/110	4,18
160/110	5,07
160/125	4,89
200/160	16,22
250/200	105,45
315/250	164,32
400/315	432,42

Alargadera M - H



Ø Diámetro	€/ud.
90	8,76
110	13,22
125	7,34
160	16,12

Manguito Bolarga

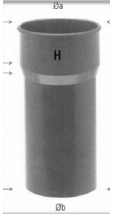

Ø Diámetro	€/ud.
75/70	12,48
90/75 _{cono}	9,78
90/80	8,68
100/90	9,18
110/100	9,18
120/100	9,68
120/110	9,76
125/120	10,26
140/120	10,37
140/125	10,37
160/150	30,19

Alargadera M - H Doble Toma



Ø Diámetro	€/ud.
110-50	9,99

Manguito Unión Mixto



Ø Diámetro	€/ud.
Ø40-1/2" Macho	1,72
Ø40-1/2" Hembra	1,72

Manguito unión a tubo metálico



Ø Diámetro	€/ud.
26-30	3,81
30-34	3,81
40-38	5,70

ACCESORIOS DE SANEAMIENTO

CODOS MACHO-HEMBRA



87° 30"

Ø Diámetro	€/ud.
110	7,22
125	11,57
160	17,52
200	37,70
250	89,19
315	127,62

TEJA JUNTA ELASTICA



45°

Ø Diámetro	€/ud.
110	7,04
125	8,20
160	14,49
200	26,80
250	65,31
315	114,16

INJERTOS MACHO-HEMBRA



87° 30"

Ø Diámetro	€/ud.
110	11,39
125	28,71
160	29,93
200	62,60
250	113,46
315	242,75

TEJA JUNTA ELASTICA



45°

Ø Diámetro	€/ud.
110	14,15
125	17,90
160	36,48
200	73,39
250	115,43
315	280,92

MANGUITO DILATACIÓN

JUNTA ELASTICA



Ø Diámetro	€/ud.
110	5,82
125	8,10
160	15,41
200	24,11
250	60,02
315	85,29

REDUCCIÓN EXCÉNTRICA

JUNTA ELASTICA



Ø Diámetro	€/ud.
160-110	9,43
160-125	12,28
200-160	18,59
250-200	73,23
315-250	128,04
400-315	157,20

INJERTOS

JUNTA PEGADA Y JUNTA MECANICA

Injerto 45°



Med	200-160	250-160	315-160	400-160
€/ud.	66,33	84,35	109,13	144,11

Injerto 90°



Med	200-160	250-160
€/ud.	44,87	56,17

Injerto junta mecánica Easy Clip



Med	500/630-160	500/630-200
€/ud.	99,94	106,19

Injerto junta mecánica



Med	250-160	315-160	315-200	400-160	400-200	500-160	500-200
€/ud.	57,75	50,48	51,20	55,10	56,30	60,20	61,40

CALDERETAS Y SUMIDEROS



Caldereta PVC salida vertical con rejilla alta

	Modelo	MEDIDA		€/ud.
		Ø Salida	Rejilla	
S-258		110	200x200	50,42
		110	250x250	58,37
		125	300x300	107,82

Caldereta sifónica extensible, horizontal, rejilla alta

	Modelo	MEDIDA		€/ud.
		Ø Salida	Rejilla	
S-388		110	200x200	52,16
		110	250x250	60,86
		125	300x300	121,04

Sumidero sifónico salida vertical, rejilla PVC y PP

	Modelo	MEDIDA		€/ud.
		Ø Salida	Rejilla	
S-246		75	200x200	26,11
		90	250x250	35,06
		110	250x250	35,06
		125	300x300	56,04
INOX		90	250x250	208,93
		110	250x250	208,93

Caldereta sifónica extensible, salida vertical rejilla PVC y PE

	Modelo	MEDIDA		€/ud.
		Ø Salida	Rejilla	
S-247		75	150x150	31,21
		90	200x200	50,17
		90	250x250	55,24
		110	250x250	55,24
INOX		90	200x200	208,93
		110	250x250	229,97

Caldereta sifónica extensible, salida horizontal, rejilla PVC

	Modelo	MEDIDA		€/ud.
		Ø Salida	Rejilla	
S-248		75	150x150	31,21
		90	200x200	49,92
		110	200x200	55,46
		110	250x250	62,26
INOX		90	200x200	158,72
		110	250x250	232,70

Sumidero sifónico extensible, vertical

	Modelo	MEDIDA		€/ud.
		Ø Salida	Rejilla	
S-150		40/50	105x105	14,09

Bote PVC, tapa expansión, embellecedor inox, 5 salidas

	Modelo	MEDIDA		€/ud.
		Ø Salida	Rejilla	
S-153		40/50	105x150	26,50

Sumidero sifónico extensible, vertical/horizontal, rejilla

	Modelo	MEDIDA		€/ud.
		Ø Salida	Rejilla	
S-191 Inox		50/40	104x104	12,00
S-192 Inox		50/40	104x104	12,00
S-191		50/40	104x104	10,76
S-192		50/40	104x104	10,76
S-20		75	150x150	12,96
S-23		110	250x250	33,39

SUMIDEROS DE FUNDICIÓN



Sumidero Patio	
Medida	€/ud.
150x150x80	19,80
200x200x80	21,50
250x250x90	23,75
300x300x100	32,50

SUMIDEROS DE ACERO INOXIDABLE SELECT

	Inox	MEDIDA		€/ud.
		100x100	104,80	
		150x150	131,96	
200x200	159,40			





Sumidero para Tráfico Pesado	
Medida	€/ud.
20x20 DN100	179,30

VALVULAS DE ESFERA

PP/PVC

	Válvula rosca hembra PP						
	Med	1/2"	3/4"	1"	1 1/4"	1 1/2"	2"
	€/ud.	15,94	21,82	28,30	39,41	53,04	77,64

	Válvula rosca hembra PVC						
	Med	1/2"	3/4"	1"	1 1/4"	1 1/2"	2"
	€/ud.	12,25	14,68	22,03	26,70	37,99	51,80

	Válvula encolar PVC										
	Med	20	25	32	40	50	63	75	90	110	125
	Jimtem	12,25	14,68	22,03	24,53	32,75	52,22	241,16	265,42	482,84	578,21
	Cepex	11,31	12,43	16,44	19,01	26,16	35,59	126,77	172,80	310,50	336,15

	Válvula mariposa PVC							
	Med	63-75	90	110	125-140	160	200-225	250
	€/ud.	99,50	115,97	128,66	153,09	188,46	280,13	712,80

	Válvula retención PVC Muelle/Bola						
	Med	32	40	50	63	75	90
	Muelle €/ud.	16,00	19,67	26,16	36,87	79,92	105,71
	Bola €/ud.	39,24	44,45	59,30	84,60	175,20	251,25

GESTION DEL AGUA

	Válvula antirretorno con registro lbide						
	Med	110	125	160	200	250	315
	Color	Gris	Gris	Gris	Gris	Teja	Teja
	€/ud.	194,38	196,00	303,35	543,95	526,28	723,81

	Sifón en línea con registro lbide						
	Med	110	125	160	200	160	200
	Color	Gris	Gris	Gris	Gris	Teja	Teja
	€/ud.	40,61	41,13	98,19	168,37	98,19	168,14

PRESION

SERIE ENCOLAR

Codo H - H a 90°



Desarrollo	€/ud.
20	0,52
25	0,63
32	0,98
40	1,35
50	1,87
63	2,86
75	5,27
90	8,90
110	16,60
125	23,87
140	40,84
160	47,65
200	74,90

Codo H - H a 45°



Desarrollo	€/ud.
20	0,76
25	0,99
32	1,32
40	1,64
50	2,05
63	2,97
75	5,94
90	8,95
110	14,73
125	21,41
140	39,79
160	42,14
200	62,60

Te igual a 90°



Desarrollo	€/ud.
20	0,62
25	0,89
32	1,18
40	2,08
50	2,57
63	3,66
75	7,69
90	14,12
110	20,65
125	33,84
140	51,50
160	61,00
200	97,60

Casquillo Reductor



Desarrollo	€/ud.
25/20	0,47
32/25	0,47
40/32	0,75
50/40	0,97
63/50	1,27
75/63	2,27
90/75	3,71
110/90	6,71
125/110	8,71
140/125	12,70
160/140	16,60
200/160	29,91

Tapón Hembra



Desarrollo	€/ud.
20	0,50
25	0,58
32	0,78
40	1,22
50	1,77
63	2,45
75	4,64
90	7,56
110	15,28
125	21,41
140	27,98
160	32,33
200	-

Manguito H - H



Desarrollo	€/ud.
20	0,63
25	0,76
32	0,89
40	1,32
50	1,47
63	2,18
75	4,54
90	5,94
110	9,59
125	16,98
140	25,13
160	29,47
200	51,00

Unión 3 Piezas H - H



Desarrollo	€/ud.
20	2,08
25	2,40
32	3,38
40	4,07
50	4,33
63	6,54
75	21,14
90	27,98
110	40,91

Manguito para Brida



Desarrollo	€/ud.
20	1,20
25	1,41
32	1,53
40	1,97
50	2,45
63	3,02
75	4,13
90	6,20
110	7,22
125	10,22
140	13,65
160	17,57
200	32,15

Brida

Junta



Brida	€/ud.	Junta	€/ud.
20	3,10	20	0,71
25	3,57	25	0,78
32	3,94	32	0,82
40	4,58	40	1,03
50	5,15	50	1,04
63	5,66	63	1,09
75	7,35	75	1,27
90	7,84	90	1,50
110	10,65	110	1,77
125	15,28	125	2,00
140	17,37	140	2,00
160	21,00	160	2,34
200	25,37	200	4,71

PRESION

SERIE MIXTA

FLUIDRA

Terminal Rosca Macho



Medida	€/ud.
25-20 - 1/2"	1,02
32-25 - 3/4"	1,14
40-32 - 1"	1,15
50-40 - 1 1/4"	1,52
63-50 - 1 1/2"	3,20
75-63 - 2"	5,09
90-75 - 2 1/2"	7,37
110-90 - 3"	17,07

Adaptador Mixto EH y RH



Medida	€/ud.
25-20 - 1/2"	1,44
32-25 - 3/4"	1,94
40-32 - 1"	2,49
50-40 - 1 1/4"	3,53
63-50 - 1 1/2"	5,30
75-63 - 2"	7,41
90-75 - 2 1/2"	13,14
110-90 - 3"	17,93

Te igual a 90° H-M Mixta



Ø	Rosca	€/ud.
20	1/2"	1,44
25	3/4"	1,64
32	1"	2,06
40	1 1/4"	3,37
50	1 1/2"	4,62
63	2"	7,50
75	2 1/2"	17,21
90	3"	25,78
110	4"	42,51

Unión 3 piezas Mixto



Medida	Hembra €/ud.	Macho €/ud.
20 - 1/2"	2,43	2,85
25 - 3/4"	2,87	3,16
32 - 1"	3,83	3,83
40 - 1 1/4"	4,80	4,70
50 - 1 1/2"	5,76	4,49
63 - 2"	8,38	7,26
75 - 2 1/2"	23,49	22,81
90 - 3"	29,94	29,94
110 - 4"	47,59	47,59

Codo H-H 90° Mixto



Ø	Rosca	€/ud.
20	1/2"	1,14
25	3/4"	1,32
32	1"	1,76
40	1 1/4"	2,32
50	1 1/2"	3,45
63	2"	4,82

Machón Doble Rosca



Rosca	€/ud.
1/2"	0,95
3/4"	1,11
1"	1,32
1 1/4"	1,64
1 1/2"	2,14
2"	2,73

Te Rosca Hembra



Ø	Rosca	€/ud.
20	1/2"	2,06
25	3/4"	2,27
32	1"	2,78
40	1 1/4"	4,38
50	1 1/2"	6,11
63	2"	9,81
75	2 1/2"	19,85
90	3"	26,30
110	4"	48,14

Tapón Roscado PVC



Medida	Hembra €/ud.	Macho €/ud.
1/2"	1,11	0,77
3/4"	1,20	0,95
1"	1,48	1,32
1 1/4"	2,06	1,77
1 1/2"	2,69	2,30
2"	3,60	2,69
2 1/2"	-	4,77
3"	-	7,71
4"	-	15,09

Reducción M-H



Rosca	€/ud.
3/4" 1 1/2"	1,18
1" 3/4"	1,44
1 1/4" 1"	1,78
1 1/2" 1 1/4"	2,04

ADHESIVOS



PVC presión



Peso	€/ud.
Tubo 125 cc	4,05
Bote 250 cc	9,18
Bote 500 cc	14,31

PVC evacuación



Peso	€/ud.
Tubo 125 cc	3,02
Para Flexible	4,83
Bote 500 cc	10,78

Disolvente



Peso	€/ud.
Bote 500 cc	7,34
Bote 1 litro PE	12,98

Coquilla



Peso	€/ud.
Bote 500 ml	11,05

PVC Tangit



Peso	€/ud.
Tubo 125 cc	10,47
Bote 250 cc	20,37
Bote 500 cc	33,25
Bote 1 kg	55,48

Unilock hilo teflón



Peso	€/ud.
160 mts	15,65

Metalock roscas metálicas



Peso	€/ud.
50 ml	38,60

Plastilock roscas plástico y metal



Peso	€/ud.
125 grs.	23,10

Espuma poliuretano 750 ml.



Peso	€/ud.
Cánula	10,35
Pistola	12,39

Lubricante



Peso	€/ud.
1 kg	7,90
5 kg	36,95

Sella y Pega SP (Henkel) Poliuretano



Peso	€/ud.
300 ml	9,87

Pega y sella todo tipo de materiales

Silicona transparente/blanca



Peso	€/ud.
Neutra	9,49
Sani-Sell	4,99

ABRAZADERAS TUBO

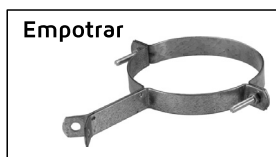

Ø	€/ud.
50	2,69
75	2,93
90	3,16
110	3,54
125	4,26
160	6,34
200	7,92
250	10,73
315	11,95



Ø	€/ud.
50	2,71
75	2,80
90	2,93
110	3,07
125	3,26
160	3,92
200	4,84
250	9,05
315	11,38



Ø	€/ud.
50	1,23
63	1,07
75	1,11
90	1,20
110	1,29
125	1,41
160	1,92
200	2,26
250	3,19



Ø	€/ud.
35	1,14
40	1,26
50	1,41
60	1,61
75	1,63
90	1,78
110	2,18
125	2,53
160	3,26
200	4,16
250	5,20
315	7,16



Ø	€/ud.
32	0,40
40	0,41
50	0,51
63	1,55
75	2,03
90	2,35
110	4,52
125	5,11
160	6,76

Longitud	€/ud.
10 ml	3,26

FITTING GAMA 55



Enlace rosca macho



K61

Ø	€/ud.
20 x 1/2"	2,49
25 x 3/4"	3,12
32 x 1"	4,99
40 x 1 1/4"	6,67
50 x 1 1/2"	8,91
63 x 2"	13,51
75 x 2 1/2"	23,80
90 x 3"	38,57
110 x 4"	84,00

Enlace rosca hembra



K62

Ø	€/ud.
20 x 1/2"	3,06
25 x 3/4"	3,86
32 x 1"	5,10
40 x 1 1/4"	7,05
50 x 1 1/2"	9,71
63 x 2"	14,43
75 x 2 1/2"	25,83
90 x 3"	40,76
110 x 4"	101,87

Enlace recto



K63

Ø	€/ud.
20	4,03
25	4,88
32	6,93
40	10,88
50	15,72
63	23,70
75	40,76
90	67,90
110	160,25

Enlace reducido



K63r

Ø	€/ud.
25-20	4,88
32-25	10,88
40-32	10,88
50-40	15,23
63-50	22,90
75-63	40,55
90-75	67,90
110-90	102,23

Te rosca hembra



K65

Ø	€/ud.
20 x 1/2"	5,12
25 x 3/4"	7,20
32 x 1"	9,92
40 x 1 1/4"	12,88
50 x 1 1/2"	18,68
63 x 2"	29,34
75 x 2 1/2"	51,62
90 x 3"	78,77
110 x 4"	171,76

Codo a 45° macho



K70

Ø	€/ud.
20 x 1/2"	4,05
25 x 3/4"	4,99
32 x 1"	6,30
40 x 1 1/4"	8,21
50 x 1 1/2"	10,87
63 x 2"	17,06

Codo hembra a 90°



K71

Ø	€/ud.
20 x 1/2"	6,11
25 x 3/4"	6,03
32 x 1"	7,60
40 x 1 1/4"	9,49
50 x 1 1/2"	14,20
63 x 2"	17,41

Codo tubo-tubo



K64

Ø	€/ud.
20	4,03
25	4,88
32	7,14
40	10,88
50	15,72
63	23,66
75	42,07
90	70,05
110	171,76

Codo placa



K72

Ø	€/ud.
20 x 1/2"	6,64
25 x 3/4"	7,33
32 x 1"	10,43

Codo macho a 90°



K69

Ø	€/ud.
20 x 1/2"	4,05
25 x 3/4"	4,97
32 x 1"	6,30
40 x 1 1/4"	8,21
50 x 1 1/2"	11,20
63 x 2"	17,06

Te tres bocas



K73

Ø	€/ud.
20	6,11
25	7,33
32	10,43
40	16,26
50	23,74
63	35,71

Cruz



K76

Ø	€/ud.
32	23,45
40	36,63
50	53,01

Reducción M-H



K67r

Ø	€/ud.
3/4"-1/2"	1,53
1"-1/2"	1,86
1"-3/4"	1,86
1 1/4"-1/2"	2,75
1 1/4"-3/4"	2,75
1 1/4"-1"	2,75
1 1/2"-1"	3,77
1 1/2"-1 1/4"	3,77
2"-1"	6,05
2"-1 1/4"	6,05
2"-1 1/2"	6,05
2 1/2"-2"	8,27

Tapón



K78

Ø	€/ud.
20	3,24
25	3,63
32	5,65
40	7,01
50	10,33
63	14,87
75	26,51
90	43,37
110	87,79

Collarín PPRFV



Ø	Toma	€/ud.
25	1/2"	2,28
32	3/4"-1/2"	2,87
40	1/2"-1"	3,53
50	1/2"-1"	5,05
63	1/2"-1 1/2"	6,09
75	1/2"-2"	8,09
90	1/2"-2"	12,17
110	1/2"-2"	14,13
125	2"	20,03

Enlace brida



K66

Ø	€/ud.
50	22,62
63	28,10
75	41,91
90	64,95
110	121,78

Codo 90° rosca lateral



K90

Ø	€/ud.
25 x 1/2"	5,76
32 x 3/4"	8,84

ACCESORIO DE LATON

PARA TUBERIA DE POLIETILENO



Enlace Mixto Rosca-M MK 61



Med.	€/ud.
16 x 1/2"	2,66
20 x 1/2"	4,54
25 x 3/4"	6,64
32 x 1"	9,24
40 x 1 1/4"	14,62
50 x 1 1/2"	20,52
63 x 2"	31,55
75 x 2 1/2"	95,27
90 x 3"	139,46
110 x 4"	307,53

Enlace Mixto Rosca-H MK 62



Med.	€/ud.
16 x 1/2"	2,73
20 x 1/2"	4,54
25 x 3/4"	6,64
32 x 1"	9,24
40 x 1 1/4"	14,62
50 x 1 1/2"	20,52
63 x 2"	31,55
75 x 2 1/2"	99,08
90 x 3"	143,27
110 x 4"	309,33

Manguito Doble MK 63



Med.	€/ud.
16	4,86
20	8,22
25	12,85
32	17,50
40	23,14
50	30,99
63	52,14
75	182,91
90	248,48
110	572,18

Codo Doble MK 64



Med.	€/ud.
16	6,08
20	8,97
25	13,29
32	19,96
40	33,86
50	52,15
63	88,25
75	221,01
90	301,82

Codo Hembra MCH



Med.	€/ud.
16 x 1/2"	4,08
20 x 1/2"	6,97
25 x 3/4"	10,12
32 x 1"	14,94
40 x 1 1/4"	24,25
50 x 1 1/2"	35,40
63 x 2"	58,86
75 x 2 1/2"	170,70
90 x 3"	236,27

Codo Macho MCM



Med.	€/ud.
16 x 1/2"	4,55
20 x 1/2"	6,51
25 x 3/4"	10,13
32 x 1"	14,19
40 x 1 1/4"	24,87
50 x 1 1/2"	36,46
63 x 2"	59,48

Te Rosca-H MK 65



Med.	€/ud.
16 x 1/2"	7,18
20 x 1/2"	9,77
25 x 3/4"	16,01
32 x 1"	20,07
40 x 1 1/4"	34,66
50 x 1 1/2"	47,26
63 x 2"	79,95
75 x 2 1/2"	246,94
90 x 3"	335,35

Codo Placa MCP



Med.	€/ud.
16 x 1/2"	5,82
20 x 1/2"	11,15
25 x 3/4"	14,49
32 x 1"	22,56

Manguito ANIMA



Med.	€/ud.
20	2,50
25	2,86
32	3,49
40	4,62
50	9,00
63	12,23

ACCESORIOS ELECTROSOLDABLES +GF+ PARA TUBO DE PE

Manguito PN-16



Ø mm	ud./caja	€/ud.
20	50	4,31
25	50	5,01
32	50	5,22
40	50	5,48
50	30	8,61
63	24	8,77
75	12	12,51
90	10	16,48
110	5	20,21
125	5	28,05
140	5	32,39
160	6	37,72
200	2	74,18
250	2	128,80
315	1	318,66

Portabridas PN-16



Ø mm	ud./caja	€/ud.
32	25	3,81
40	60	4,49
50	50	4,99
63	70	5,81
75	30	7,26
90	24	9,62
110	16	12,03
125	16	14,79
140	6	19,02
160	6	21,24
200	4	38,26
250	1	119,58
315	1	183,08

Codo a 90.º PN-16



Ø mm	ud./caja	€/ud.
20/25/32	10	15,02
40	10	17,89
50	10	22,65
63	10	25,93
75	25	43,38
90	15	45,91
110	8	66,43
125	5	91,90
160	4	181,10
200	1	587,49

Reducción PN-16



Ø mm	ud./caja	€/ud.
40x25/32	20	12,44
50x32	10	14,56
50x40	15	15,03
63x32/40	10	13,58
63x50	10	16,19
90x63	30	22,32
110x90	16	33,86
125x90	12	70,46
160x110	5	58,75

Te PN-16



Ø mm	ud./caja	€/ud.
20/25	10	16,71
32	10	16,54
40	10	18,11
50	5	23,17
63	5	26,10
75	18	46,90
90	10	46,53
110	6	74,22
125	4	96,00
160	3	194,68

Codo a 45.º PN-16



Ø mm	ud./caja	€/ud.
32	20	15,30
40	10	18,28
50	10	24,81
63	10	26,40
75	25	47,27
90	20	46,86
110	12	70,76
125	6	94,65
160	5	182,87
200	1	592,46

Brida de Fundición
Galvanizada
Pintada
EPOXI PN-16



DN	ud./caja	€/ud.
40	16	9,83
50	16	10,80
65	10	13,71
80	10	15,72
100	10	17,72
125	9	18,50
140	8	21,58
150	6	26,71
200	-	35,91
250	-	41,06
300	-	67,25

Máquina Soldar

HÜRNER



Modelo	€/ud.
HST 300 Smart c/escaner	1.850,00

ACCESORIOS TOPE PN-16 +GF+

PARA TUBO DE PE

Codo a 90°



Ø mm	€/ud.
50	7,24
63	12,65
75	17,49
90	20,12
110	35,30
125	47,20
140	52,69
160	69,22
200	106,49
250	342,57
315	725,32

Codo a 45°



Ø mm	€/ud.
50	7,38
63	12,65
75	17,90
90	20,12
110	31,10
125	47,20
140	52,69
160	69,22
200	106,96
250	358,11
315	621,79

Reducción



Ø mm	€/ud.
50x40/32/25	4,95
63x32/40/50	6,85
75x63/50/40	10,44
90x75/63/50	14,39
110x90/75/63	19,16
125x110/90/75/63	23,10
140x110/90/75	34,85
140x125	33,18
160x140/125/110/90	44,48
180x110/90	52,20
180x160	54,05
200x180/160	62,81
250x200	231,18
315x250/200	395,29

Te igual



Ø mm	€/ud.
50	8,90
63	11,70
75	18,60
90	28,73
110	38,89
125	57,55
140	87,04
160	101,02
200	206,09
250	555,80
315	-

Te reducida



Ø mm	€/ud.
90x75/63	57,77
110x63	84,86
110x75	90,68
110x90	106,88
160x90/75	233,81
160x110	240,17
200x90	485,64
200x110	498,31
200x160	511,06
250x160	934,25
315x250	934,30

Tapón



Ø mm	€/ud.
32	4,40
40	5,40
50	6,85
63	8,76
75	17,01
90	20,73
110	25,18
125	28,77
140	37,81
160	39,84
180	54,83
200	68,49
250	158,20
315	304,43

Adaptador Mixto Macho



Ø mm	€/ud.
32 - 1"	21,78
40 - 1 1/4"	25,31
50 - 1 1/2"	25,72
63 - 2"	39,01
75 - 2 1/2"	97,93
90 - 3"	130,53
110 - 4"	172,44

Adaptador Mixto Hembra



Ø mm	€/ud.
32 - 1"	27,71
40 - 1 1/4"	31,81
50 - 1 1/2"	32,55
63 - 2"	43,18
75 - 2 1/2"	88,11
90 - 3"	116,81
110 - 4"	151,71

VALVULAS



Válvula Compuerta cierre elástico c/cuadradillo PN16 Serie 06/30



Med.	€/ud.
40	203,05
50	221,10
65	228,80
80	231,00
100	261,80
125	387,20
150	457,60
200	715,00
250	1.476,20
300	2.021,80

Válvula Compuerta cierre elástico roscar c/cuadradillo PN16 Serie 03/00



DN/Rosca	€/ud.
25 - 3/4"	92,40
25 - 1"	95,70
32 - 1 1/4"	113,30
40 - 1 1/2"	123,20
50 - 2"	166,10

Válvula Mariposa Wafer con palanca SYC



DN	Disco Inox	Disco Fun
50	41,36	35,09
65	50,27	42,35
80	56,10	45,65
100	82,06	59,84
125	114,18	85,91
150	136,95	100,65
200	246,95	147,84

Válvula mariposa sección "U" PN-16 Serie 820/20

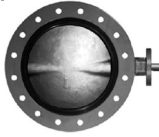

DN	€/ud.
200	1.404,90
250	2.083,20
300	2.748,90
350	3.315,90
400	4.645,20
500	10.907,40
600	17.598,00

Accionamiento manual c/ indicador de posición Serie Q



DN	€/ud.
200	85,50
250	149,40
300	149,40
350	149,40
400	222,30
500	240,30
600	488,70

VALVULA HIDRAULICA

Válvula Reductora-Sostenedora de Presión PN16 CLA-VAL

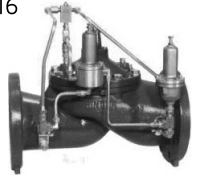

asiento progresivo "LFS"

Medida	€/ud.
DN 50	2.611,89
DN 65	2.944,64
DN 80	3.867,88
DN 100	4.823,77
DN 125	6.393,70
DN 150	7.101,91
DN 200	10.589,49

Carrete Desmontaje Inox Brida A° C°



DN	€/ud.
50	196,35
65	211,75
80	223,30
100	238,70
125	261,80
150	298,39
200	452,39

Llave en T



€/ud.
254,10

Eje Extensión fijo



L	€/ud.
L 1000	153,30
L 1500	203,70
L 2000	283,50

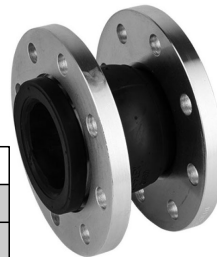

Carrete Antivibratorios Cuerpo Simple Onda PN16 EPDM - Bridas Locas Cincadas

DN	€/ud.
1"	31,33
1 1/2"	34,54
2"	44,79
50	42,19
65	52,45
80	62,37
100	75,17
125	105,41
150	140,00

Volante para Válvula de Compuerta



DN	40/50	65/80	100	125/150	200	250/300
€/ud.	31,50	29,40	29,40	52,50	86,10	174,30

ACCESORIOS FUNDICION

NORMA UNE-EN-545

EMBRIDADOS



Codo 90° BB



DN	€/ud.
80	74,16
100	85,68
125	130,32
150	162,00
200	267,84
250	408,24
300	627,84

Codo 45° BB



DN	€/ud.
80	66,96
100	88,56
125	110,16
150	146,88
200	218,16
250	372,96
300	528,48

Codo 22° y 11° BB



DN	22° €/ud.	11° €/ud.
80	67,68	61,20
100	79,92	83,52
125	98,64	103,68
150	126,72	131,76
200	192,96	187,92
250	287,28	243,36
300	407,52	428,40

Te igual BBB



DN	€/ud.
80	108,00
100	133,92
125	182,88
150	225,36
200	354,24
250	565,92
300	784,80

Te reducida BBB



DN	€/ud.
100/65-50	124,56
150/80	201,60
150/100	205,92
200/100	303,12
250/150	388,08
250/100	394,56
300/150	567,36

Reducción BB



DN	€/ud.
100/50	59,04
100/65	62,64
100/80	70,56
150/100	92,88
200/80	127,44
200/100	130,32
200/150	162,00

Placa de Reducción BB



DN	€/ud.
80/50	106,86
100/50	122,94
100/80	116,40
150/80	180,25
150/100	176,35
200/100	236,19

Brida Ciega BC



DN	€/ud.
80	25,92
100	32,40
125	38,88
150	51,12
200	80,64
250	110,88
300	155,52

Brida Liso BL



DN	€/ud.
80	60,48
100	72,00
125	96,48
150	142,56
200	177,84
250	306,00
300	356,40

Carrete Fijo BB



DN	L=250	L=500	L=1000
50	44,64	61,92	-
65	57,60	75,60	-
80	70,56	91,44	139,68
100	82,08	112,32	236,88
150	131,76	191,52	252,00
200	190,80	259,92	375,12
250	224,64	400,32	491,76
300	337,65	460,08	747,36

Carrete Anclaje BB



DN	L=800	L=1000
80	147,60	-
100	176,40	-
150	266,40	-
200	382,32	-
250	556,56	-
300	-	779,04
350	-	1.090,80
400	-	1.195,92

ACCESORIOS FUNDICION

NORMA UNE-EN-545

JUNTA MECANICA



Codo 90° EE



DN	€/ud.
80	185,96
100	196,55
125	274,79
150	276,94
200	366,88
250	512,58
300	775,36

Codo 45° EE



DN	€/ud.
80	185,95
100	195,98
125	252,81
150	272,79
200	366,49
250	513,29
300	777,84

Codo 22° y 11° EE



DN	€/ud.
80	185,88
100	196,00
125	113,68
150	132,94
200	184,77
250	312,63
300	493,62

Te Enchufe Brida (EBE)



DN	€/ud.
80	212,72
100	243,34
125	320,35
150	340,08
200	476,72
250	719,06
300	1.641,23

Te Enchufe Brida Reducida (EBE)



DN	€/ud.
100/80	243,34
150/80	340,08
150/100	340,08
200/100	456,43
200/150	476,72
250/200	719,06
300/250	1.594,17

Enchufe Brida E/B



DN	€/ud.
80	121,64
100	123,99
125	156,59
150	171,74
200	238,89
250	353,32
300	480,76

Manguito Reducido EE



DN	€/ud.
100/80	209,13
150/80	272,11
200/100	348,62
200/150	382,32
250/150	532,24
250/200	552,70
300/150	679,82
300/200	700,28

Manguito E E



DN	€/ud.
80	189,72
100	194,14
125	244,40
150	262,78
200	352,93
250	596,27
300	796,04

Junta express Vi:
(acerrojada)

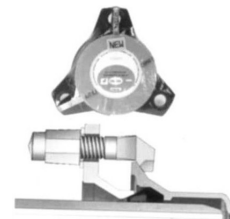

DN	€/ud.
80	120,44
100	134,47
150	173,71
200	312,97
250	537,20
300	641,94

ACCESORIOS DE UNIÓN

Unión Universal
Waga con junta
antitracción



+GF+

DN	Rango	€/ud.
50	46-71	229,57
65	63-90	318,19
80	84-105	294,33
100	104-132	344,33
125	132-155	565,93
150	154-192	596,63
200	192-232	944,37

Brida Universal
Waga con junta
antitracción



+GF+

DN	Rango	€/ud.
50	46-71	197,01
65	63-90	252,78
80	84-105	294,33
100	104-132	333,27
125	132-155	519,17
150	154-192	486,31
200	192-232	799,16

Tapón Universal
Waga con junta
antitracción
C/Rosca H



+GF+

DN	Rango	€/ud.
50	46-71	155,69
65	63-90	207,05
80	84-105	215,24
100	104-132	269,27
125	132-155	339,20
150	154-192	390,93
200	192-232	668,20

Brida Universal PN16



DN	Rango m/m	€/ud.
50/65/80	57-74	65,70
50/65/80	68-85	67,50
80/100	84-106	80,10
100/125	109-133	88,20
125/150	132-157	118,80
150	157-183	124,20
150	176-201	167,40
200	193-215	174,40
200	218-242	191,70
250	242-268	263,70
250	266-292	271,80
300	301-327	351,90
300	324-350	360,90

Unión Universal PN 16



DN	Rango m/m	€/ud.
50	57-74	63,00
65	68-85	75,60
80	84-106	87,30
80	99-119	97,20
100	109-133	99,00
125	132-157	114,30
150	157-183	142,20
175	193-215	150,30
200	218-242	188,10
225	242-268	249,30
250	266-292	267,30
300	301-327	305,10
300	352-378	453,60

Unión Universal PN 16
Gran Tolerancia



Rango m/m	Rango m/m	€/ud.
57-74	68-85	107,10
57-74	84-106	113,14
68-85	84-106	117,00
84-106	99-119	134,10
84-106	109-133	142,20
99-119	109-133	142,20
109-133	157-183	172,80
132-157	157-183	162,00
157-183	176-201	205,20
176-201	218-242	259,20
218-242	242-268	387,90
242-268	266-292	390,60
301-327	324-350	419,40

ARPOL NEO



NEO Arpol

Rango	Longitud	€/ud.
63-71	200 mm	109,00
72-84	200 mm	115,26
82-95	200 mm	117,92
109-126	200 mm	140,81
125-142	200 mm	150,60
155-172	200 mm	193,75
186-208	200 mm	261,95
206-228	200 mm	264,79
248-270	200 mm	287,57
309-331	200 mm	307,49
395-417	200 mm	338,83

Brida Doble Cámara
PN16 para PE/PVC
serie 05/60



DN/d ext	€/ud.
50/63	69,30
65/75	78,30
80/90	72,00
100/110	81,00
125/125	142,20
125/140	159,30
150/160	147,60
200/200	262,80
200/225	256,50
250/250	394,20

RETENCIONES-FILTROS-COLLARINES

Collarín para PVC/PE



Ø	3/4" a 2"	€/ud.
50		24,02
63		27,13
75		29,55
90		36,67
110		42,64
125		51,74
140		58,61
160		67,54
200		99,22
250		144,14
315		166,89

Collarín salida brida



Ø	Brida DN	€/ud.
110	65	183,30
110	80	193,75
125	80	206,03
140	80	223,19
160	50	239,91
160	100	295,93
200	50	284,09
200	80	313,19
200	100	315,92

Ventosa Trifuncional
F. Dúctil
Bola A°I°
PN-16



Medida	€/ud.
1"	264,30
2"	395,89
DN 50	482,00
DN 65	604,58
DN 80	1.031,57
DN 100	1.526,36

Filtro Colador c/bridas
PN16 - Abertura 2 m/m



DN	€/ud.
40	332,83
50	332,83
65	357,34
80	467,15
100	511,22
125	922,59
150	880,66
200	1.613,49

Válvula Antirretorno
Clapeta elástica



DN	€/ud.
40	145,93
50	156,45
65	301,53
80	278,30
100	446,97
125	537,85
150	790,25
200	1.172,37

Válvula Retención
Disco partido
Disco inox
AISI 316



DN	€/ud.
40	41,53
50	42,67
65	49,95
80	66,28
100	82,62
125	111,47
150	164,04
200	299,48

Filtro en Y



DN	€/ud.
40	46,28
50	76,43
65	108,90
80	125,58
100	164,09
125	240,82
150	333,14
200	594,69

Cabezal Torre



Rosca	1 1/2"	1"
€/ud.	53,82	39,69



Banda para FD

DN	Campo	€/ud.
90 - 110	FD 80	23,79
110 - 130	FD 100	26,40
130 - 150	FD 125	28,29
160 - 180	FD 150	31,23
190 - 210	FD 175	34,97
220 - 240	FD 200	37,91

CONTADORES - ACOMETIDAS

Contador S-110
pequeño calibre
R80



Medida	Fria	Caliente
13 mm	54,85	55,20
15 mm	54,85	55,20
20 mm	66,55	72,85

Contador S-150
R-125



Medida	€/ud.
1/2"	58,45
3/4"	58,45
1"	76,20

Contador M-120 I



Medida	€/ud.
25 mm	161,50
30 mm	173,50
40 mm	229,20

Contador Gran Calibre
Woltmann
H4000I



Clase B

Medida	€/ud.
DN 50	527,90
DN 65	643,30
DN 80	789,30
DN 100	975,20
DN 125	1.126,00
DN 150	1.389,20
DN 200	2.829,50

Conexiones



conex conta	contador	conexión roscada	€/ud.
7/8" - 3/4"	13 mm	1/2"	7,11
3/4"	15 mm	1/2"	6,60
1"	20 mm	3/4"	10,91
1 1/4"	25 mm	1"	24,21
1 1/2"	30 mm	1 1/4"	29,61
2"	40 mm	1 1/2"	37,92

Emisor
de impulsos



Modelo	conta	€/ud.
PR7 1:10	H4000I	114,31
PR7 10:100	H4000I	114,31
PR6 1:10	S110	114,31
FALCOM MJ	M120I	114,31

Contador
Módulo
Vía
Radio



Medida	€/ud.
15 mm	102,50
20 mm	115,00

Válvula Cerradura H-H



Medida	€/ud.
1/2"	128,70
3/4"	141,80
1"	152,80

Válvula Trifuncional H-H



Medida	€/ud.
1/2"	81,40
3/4"	107,80
1"	140,00

Tornillo-Tuerca-Arandela
DIN 931
DIN 934
DIN 125



Calidad 8.8

Medida	€/ud.
16x60	1,11
16x70	1,19
16x80	1,23
16x100	1,43
20x60	1,80
20x70	1,94
20x80	2,09
20x100	2,48
20x120	2,65
24x80	3,34
24x100	3,86
27x100	7,14
30x120	11,51

Bridas Inox
AISI-304



DN	€/ud.
40 (1"-1/2")	57,88
50 (1 1/2"-2")	74,40
65 (2"-2 1/2")	86,32
80 (2"-3")	100,06
100 (2"-4")	106,68
150 (2"-4")	178,50

Varilla Roscada



Métrica	€/ud.
8	1,76
10	2,80
16	7,32
20	11,51
24	17,08

Válvula Esfera HH
Mando Palanca



Medida	Aster PN25 €/ud.	Tajo PN50 €/ud. Palanca Inox	Turja PN40 €/ud.
1/2"	8,01	13,70	9,78
3/4"	11,25	19,78	14,04
1"	16,33	29,70	20,71
1 1/4"	28,65	45,48	36,56
1 1/2"	41,57	70,94	56,28
2"	65,03	104,10	81,15
2 1/2"	159,34	-	173,09
3"	215,33	-	202,69
4"	401,85	-	-

Boca de Riego



Medida	€/ud.
15 x 1/2"	12,34
20 x 3/4"	16,66
25 x 1"	23,58

Válvula Esfera HH
Mando Mariposa



Medida	€/ud.
3/8"	10,15
1/2"	10,15
3/4"	14,50

Válvula de Retención HH
Tipo Muelle



Medida	€/ud.
1/2"	8,24
3/4"	10,88
1"	14,43
1 1/4"	20,81
1 1/2"	28,80
2"	39,82
2 1/2"	81,06

Filtro
Acero
Inoxidable



Medida	€/ud.
1/2"	0,67
3/4"	0,80
1"	1,08
1 1/4"	1,63
1 1/2"	2,27
2"	2,82
2 1/2"	6,10

Grifo curvo con boquilla
Mando Palanca



Medida	€/ud.
1/2"	13,11
3/4"	18,86
1"	28,07

Válvula de Retención HH
Tipo Clapeta



Medida	€/ud.
1/2"	13,01
3/4"	16,34
1"	24,05
1 1/4"	31,44
1 1/2"	47,80
2"	67,14
2 1/2"	98,19
3"	154,02
4"	249,69

Filtro latón CIM



Medida	€/ud.
1/2"	5,92
3/4"	9,58
1"	31,30
1 1/4"	46,92
1 1/2"	57,32
2"	100,46
2 1/2"	189,00
3"	286,86
4"	-

Válvula Esfera HH
Mando Arqueta



Medida	€/ud.
1/2"	13,25
3/4"	17,82
1"	26,34

Racor dilatación CIM



Medida	€/ud.
3/4"	21,65
1"	31,05
1 1/4"	51,15
1 1/2"	53,71
2"	77,61

Válvula de Esfera Paso Total
AISI316 Inoxidable



Medida	€/ud.
1/2"	18,29
3/4"	24,64
1"	36,52
1 1/4"	54,27
1 1/2"	74,32
2"	121,23

TUBERIA DE ACERO NEGRO C/SOLDADURA

TUBOS EN 10255 SERIE M

LG 6.000 M - DIN 2440

TUBOS EN 10255 SERIE L2

LG 6.000 M - ISO LIG II

Negro Liso - Dimensión			€/m.l.
1/2"	21,3	2,6	3,37
3/4"	26,9	2,6	4,02
1"	33,7	3,2	5,96
1 1/4"	42,4	3,2	7,57
1 1/2"	48,3	3,2	8,72
2"	60,3	3,6	12,90
2 1/2"	76,1	3,6	15,90
3"	88,9	4,0	20,76
4"	114,3	4,5	30,83
5"	139,7	5,0	39,91
6"	168,3	5,0	51,87

Negro Liso - Dimensión			€/m.l.
1/2"	21,3	2,0	2,65
3/4"	26,9	2,3	3,54
1"	33,7	2,6	4,90
1 1/4"	42,4	2,6	6,22
1 1/2"	48,3	2,9	7,90
2"	60,3	2,9	10,00
2 1/2"	76,1	3,2	14,15
3"	88,9	3,2	16,67
4"	114,3	3,6	24,64
5"	139,7	3,75	37,51
6"	168,3	3,75	48,76

ACCESORIOS DE ACERO PARA SOLDAR EN 10253-1 acero s235



Dimensión	€/m.l.
1/2"	1,74
3/4"	1,74
1"	2,22
1 1/4"	2,82
1 1/2"	3,48
2"	5,40
2 1/2"	8,40
3"	12,24
4"	22,92



Dimensión	€/m.l.
1/2"	1,74
3/4"	1,74
1"	2,10
1 1/4"	2,70
1 1/2"	3,36
2"	5,40
2 1/2"	7,92
3"	11,46
4"	20,76



Dimensión	€/m.l.
1/2"	5,88
3/4"	6,66
1"	7,14
1 1/4"	8,64
1 1/2"	10,98
2"	14,04
2 1/2"	22,44
3"	31,38
4"	46,38

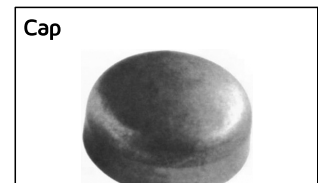

Dimensión	€/m.l.
3/4"	1,02
1"	1,02
1 1/4"	1,08
1 1/2"	1,14
2"	1,50
2 1/2"	2,16
3"	2,58
4"	7,26



Dimensión	€/m.l.
1/2"x34	0,79
3/4"x36	1,07
1"x43	1,32
1 1/4"x48	2,10
1 1/2"x48	2,58
2"x56	3,78
2 1/2"x65	7,50
3"x71	8,76
4"x83	16,32



Dimensión	€/m.l.
1/2"x100	1,26
3/4"x100	1,50
1"x100	2,04
1 1/4"x100	2,70
1 1/2"x100	3,36
2"x100	4,20
2 1/2"x100	6,54
3"x100	7,92
4"x100	11,46



Material P250 GH	€/m.l.	
	PLANA	CUELLO
DN25 10/16	8,10	13,28
DN32 10/16	11,16	21,06
DN40 10/16	12,78	25,98
DN50 10/16	15,78	26,76
DN65 10/16	19,86	29,28
DN80 10	25,14	35,34
DN80 16	25,14	35,34
DN100 10/16	26,64	50,52
DN125 10/16	34,74	79,86
DN150 10/16	44,10	98,28
DN200 10	62,28	105,12



Reducción concéntrica	€/m.l.	
3/4"-1/2"	4,08	3,72
1"-3/4"	3,66	4,74
1"-1/2"	4,08	4,86
1 1/4"-1"	3,96	4,86
1 1/4"-3/4"	4,56	7,86
1 1/2"-1 1/4"	4,20	4,20
1 1/2"-1"	4,86	5,40
2"-1 1/2"	5,40	6,48
2"-1 1/4"	6,06	6,78
2 1/2"-2"	7,08	10,26
3"-2 1/2"	9,24	12,84
4"-3"	14,08	20,58

ACCESORIOS ROSCADOS LATON-HIERRO MALEABLE

LATON: EN 1254 APLICACIONES DE FONTANERÍA Y CALEFACCIÓN. ROSCAS CILÍNDRICAS

HIERRO MALEABLE: EN 10242 GALVANIZADO. T°: -20° a 300°. PRESIÓN: 20-25 BARES. ROSCA INTERNA: CILÍNDRICA, EXTERNA: CÓNICA

Figura 280



Contrarrosca M-M

Medida	€/LATÓN	€/HIERRO
3/8"	1,31	2,76
1/2"	1,66	1,36
3/4"	2,47	1,58
1"	4,79	2,12
1 1/4"	9,78	3,86
1 1/2"	12,51	5,08
2"	17,21	8,07
2 1/2"	29,72	24,06
3"	45,67	37,33
4"	142,57	75,50

Figura 245



Contrarrosca Reducida M-M

Medida	€/LATÓN	€/HIERRO
1/2-3/8	1,66	3,21
3/4-1/2	2,51	2,63
1"-3/4	4,11	3,28
1"-1/2	3,94	5,89
1 1/4-1	8,22	5,56
1 1/2-1 1/4	10,54	8,06
1 1/2-1	10,05	12,25
2-1 1/2	16,39	13,33
2 1/2-2	28,89	26,92
3-2 1/2	44,92	47,97
4"-3"	96,73	137,26

Figura 529



Racord Marsella H-M

Medida	€/LATÓN	€/HIERRO
3/8"	1,25	3,07
1/2"	1,79	3,15
3/4"	2,86	4,52
1"	5,13	7,05
1 1/4"	9,93	14,33
1 1/2"	13,40	20,80
2"	12,93	34,80

Figura 241



Reducción Hexagonal M-H

Medida	€/LATÓN	€/HIERRO
1/2-3/8	2,41	1,46
3/4-1/2	3,36	1,53
1"-3/4	6,21	2,27
1"-1/2	7,41	2,27
1 1/4-1	8,54	3,07
1 1/2-1 1/4	11,18	3,78
1 1/2-1	10,79	3,86
2-1 1/2	20,30	7,27
2 1/2-2	30,03	19,43
3-2 1/2	-	24,34
4"-3"	-	42,86

Figura 90



Codo 90° H-H

Medida	€/LATÓN	€/HIERRO
3/8"	2,77	2,11
1/2"	4,37	1,38
3/4"	5,67	1,90
1"	11,37	2,92
1 1/4"	25,33	4,99
1 1/2"	26,23	6,49
2"	48,54	10,21
2 1/2"	121,40	35,42
3"	161,20	51,60
4"	276,35	85,55

Figura 130



Te Igual H-H-H

Medida	€/LATÓN	€/HIERRO
3/8"	3,52	3,04
1/2"	5,19	1,90
3/4"	7,20	2,76
1"	12,98	4,15
1 1/4"	25,05	7,62
1 1/2"	29,71	9,49
2"	54,29	14,33
2 1/2"	171,07	50,33
3"	243,44	60,57
4"	351,62	111,42

Figura 270



Manguito H-H

Medida	€/LATÓN	€/HIERRO
3/8"	2,03	2,06
1/2"	3,08	1,32
3/4"	4,60	1,61
1"	6,81	2,11
1 1/4"	11,08	3,71
1 1/2"	14,34	4,99
2"	21,37	7,99
2 1/2"	74,52	27,36
3"	96,09	35,99
4"	131,17	75,50

Figura 290

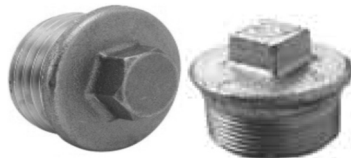

Tapón M

Medida	€/LATÓN	€/HIERRO
3/8"	1,09	1,44
1/2"	1,39	1,00
3/4"	2,32	1,36
1"	3,59	1,77
1 1/4"	6,21	3,37
1 1/2"	8,64	4,43
2"	13,26	6,64
2 1/2"	-	15,96
3"	-	20,37
4"	149,52	34,34

Figura 300



Tapón H

Medida	€/LATÓN	€/HIERRO
3/8"	0,91	1,76
1/2"	1,15	1,67
3/4"	1,81	2,11
1"	3,47	2,76
1 1/4"	6,11	4,94
1 1/2"	8,30	5,70
2"	13,96	9,42
2 1/2"	29,81	20,15
3"	44,09	22,85
4"	70,57	35,43

ACCESORIOS ROSCADOS LATON-HIERRO MALEABLE

LATON: EN 1254 APLICACIONES DE FONTANERÍA Y CALEFACCIÓN. ROSCAS CILÍNDRICAS

HIERRO MALEABLE: EN 10242 GALVANIZADO. T°: -20° a 300°. PRESIÓN: 20-25 BARES. ROSCA INTERNA: CILÍNDRICA, EXTERNA: CÓNICA

Figura 340



Unión Tres Piezas H-H

Medida	€/LATÓN	€/HIERRO
3/8"	-	9,08
1/2"	12,22	7,92
3/4"	17,44	9,97
1"	27,62	11,72
1 1/4"	38,11	16,73
1 1/2"	46,19	20,80
2"	70,99	32,08
2 1/2"	-	67,62
3"	-	101,45
4"	-	190,26

Figura 240



Manguito Botella Red. H-H

Medida	€/LATÓN	€/HIERRO
1/2"-3/8"	3,96	2,55
3/4"-1/2"	4,48	2,76
1"-3/4"	5,70	3,43
1 1/4"-1"	10,79	6,27
1 1/2"-1 1/4"	14,54	7,99
2"-1 1/2"	15,29	16,92
2 1/2"-2"	-	32,32
3"-2 1/2"	-	52,21
4"-3"	-	87,57

TUBOS SÓNICOS OBRA CIVIL

Tubería de acero negra, soldado longitudinalmente, roscado. Tubos de 6 m.l.

Medida	€/m.l.
Ø 60.3x2.3 mm 2"	7,06
Ø 88.9x2.5 mm 3"	11,42
Ø 114.3x2.5 mm 4"	14,78



ACCESORIOS ROSCADOS EN ACERO NEGRO

Unión 3 Piezas
Asiento plano H-H
Fig. 330



Medida	€/ud.
2"	24,39
3"	79,43
4"	153,34

Manguito Roscado
Ref. 100



Medida	€/ud.
2"	3,78
3"	8,76
4"	7,26

Tapón Roscado
Fig. 300



Medida	€/ud.
2"	9,42
3"	22,85
4"	35,43

Manguito Mixto
Rosca H-Soldar



Medida	€/ud.
2"	6,60
3"	13,89
4"	21,92

Tapón de Polietileno
Baja Densidad

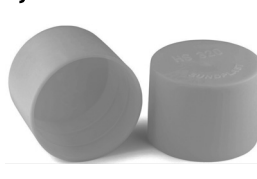

Medida	€/ud.
60,4	1,29
88,9	2,06
114,3	2,38

SISTEMA DE UNION PRESSFITTING

PARA MULTICAPA y PE-X



Tubo en Rollo	Medida	Multicapa	PE-X
	16	1,49	1,10
	18	1,89	-
	20	1,95	1,47
	25	3,48	2,24
	Aislado 16	1,99	

Enlace Macho	Medida	Multicapa	PE-X
	16 x 1/2"	3,92	2,85
	18 x 1/2"	4,25	-
	20 x 1/2"	4,14	3,20
	20 x 3/4"	4,97	4,53
	25 x 3/4"	7,55	6,16

Enlace Hembra	Medida	Multicapa	PE-X
	16 x 1/2"	4,22	2,92
	18 x 1/2"	4,37	-
	20 x 1/2"	4,74	3,31
	20 x 3/4"	6,36	4,43
	25 x 3/4"	7,25	6,05

Racor Móvil	Medida	Multicapa	PE-X
	16 x 1/2"	5,26	2,93
	18 x 1/2"	5,93	-
	20 x 1/2"	6,91	3,34
	20 x 3/4"	8,53	4,48
	25 x 3/4"	11,83	6,09

Codo Igual	Medida	Multicapa	PE-X
	16	3,97	4,07
	18	5,13	-
	20	5,21	4,42
	25	8,43	8,32

Codo Hembra	Medida	Multicapa	PE-X
	16 x 1/2"	4,59	4,07
	18 x 1/2"	4,97	-
	20 x 1/2"	5,45	4,65
	20 x 3/4"	7,77	8,44
	25 x 3/4"	8,68	9,49

Manguito Reducido	Medida	Multicapa	PE-X
	20-16	4,02	4,07
	18-16	4,05	-
	25-20	6,89	6,88
	25-16	6,48	6,50

Accesorios Varios	Medida	Escariador	Muelle	Base f.	Calibrador
	16	91,38	18,99	3,02	5,26
	18	-	21,78	-	-
	20	105,02	20,57	-	-
	25	115,70	29,27	-	-

Te Igual	Medida	Multicapa	PE-X
	16	6,20	5,65
	18	6,81	-
	20	7,85	7,93
	25	13,28	14,48

Te Rosca Hembra	Medida	Multicapa	PE-X
	16 x 1/2"	7,15	7,32
	18 x 1/2"	7,68	-
	20 x 1/2"	7,78	7,66
	25 x 1/2"	-	12,42
	25 x 3/4"	15,26	14,31

Te Reducida	Medida	Multicapa	PE-X
	20x16x20	8,26	8,02
	20x20x16	8,26	8,02
	20x16x16	7,63	-
	25x16x25	13,61	13,23
	25x20x25	13,71	13,27

Te Reducida	Medida	Multicapa	PE-X
	16x18x16	8,62	-
	16x20x16	7,63	7,95
	20x16x16	-	7,95
	20x18x20	8,29	-
	25x20x20	12,90	13,23

Manguito	Medida	Multicapa	PE-X
	16	3,64	2,71
	18	3,97	-
	20	4,14	3,32
	25	7,38	7,33

Codo Placa	Medida	Multicapa	PE-X
	16 x 1/2"	6,78	5,62
	18 x 1/2"	8,68	-
	20 x 1/2"	7,67	5,89
	20 x 3/4"	-	11,08
	25 x 3/4"	-	13,20

Llave de Corte	Medida	Multicapa	PE-X	MANDO
	16	14,83	20,26	11,96
	18	-	-	11,96
	20	17,20	28,27	11,96
	25	23,71	26,29	11,96

Espesores de Tubería en mm	Medida	Multicapa	PE-X
	16	2,00	1,80
	18	2,00	
	20	2,00	1,90
	25	2,00	2,30

TUBOS Y RACORES

DE POLIBUTILENO



Tubo en Rollo

Medida	€/ud.
15 x 1,8	1,88
22 x 2,0	3,35



**Tubo en Barra
Barras 4 Mts.**

Medida	€/ud.
15 x 1,8	1,88
22 x 2,0	3,32



Manguito Unión

Medida	€/ud.
15	1,88
22	2,47



Te Rosca Hembra

Medida	€/ud.
15 x 1/2"	8,25
22 x 1/2"	10,06



Te + Casquillo

Medida	€/ud.
15	3,35
22	4,37



Te Reducida

Medida	€/ud.
22-15-22	4,39
22-15-15	4,39
22-22-15	4,39



Codo + Casquillo

Medida	€/ud.
15	2,34
22	3,05



Codo Hembra

Medida	€/ud.
15 x 1/2"	4,61
22 x 3/4"	5,83
22 x 1/2"	5,78

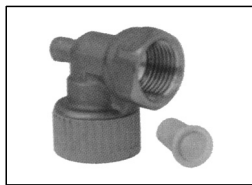

Codo con Tornillo

Medida	€/ud.
15 x 1/2"	5,43
22 x 1/2"	6,03



**Módulo Terminal
Colector**

Medida	€/ud.
22-15	4,22



Enlace Hembra

Medida	€/ud.
15 x 1/2"	4,22
22 x 1/2"	5,23
22 x 3/4"	5,37



Enlace Macho

Medida	€/ud.
15 x 1/2"	3,81
22 x 1/2"	4,61
22 x 3/4"	4,61



Llave Paso

Medida	€/ud.
15	13,08
22	19,04

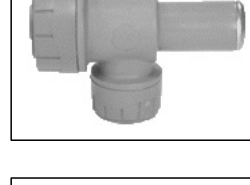

**Módulo Intermedio
Colector**

Medida	€/ud.
22-15	5,82



Reducción MH

Medida	€/ud.
22-15	2,09



Animas

Medida	€/ud.
15	0,22
22	0,33

Lubricante

Medida	€/ud.
150 ml	4,93

Todas las piezas vienen con sus ánimas correspondientes.

AISLAMIENTO TERMICO COQUILLA



TUBEX (POLIETILENO)

Medida	10x12	10x15	10x18	10x22	10x28	10x35	10x42	10x48	10x54	10x60	10x76	10x89	10x114		
Mts/caja	400	400	300	270	196	160	110	100	80	70	50	40	28		
€/m	0,35	0,36	0,43	0,50	0,62	0,68	0,90	1,07	1,32	1,46	2,06	2,38	3,63		



K-FLEX ST (CAUCHO) REACCIÓN AL FUEGO BL-S2, DØ TEMP: -165° a +110°C

Medida	9x15	9x18	9x22	9x28	9x35	9x42	9x48	9x54	9x64	9x76	9x90	9x114	9x140		
Mts/caja	192	166	136	98	76	60	50	46	46	40	36	22	16		
€/m	0,81	0,95	1,01	1,27	1,58	2,01	2,47	2,92	3,52	4,06	5,09	7,31	10,03		

Medida	13x15	13x18	13x22	13x25	13x28	13x35	13x42	13x48	13x54	13x64	13x76	13x90	13x114		
Mts/caja	136	118	98	80	78	58	48	40	34	32	26	24	16		
€/m	1,45	1,60	1,79	2,16	2,30	2,79	3,11	3,35	3,68	4,49	5,44	6,74	9,81		

Medida	19x15	19x18	19x22	19x25	19x28	19x35	19x42	19x48	19x54	19x64	19x76	19x90	19x114	19x140	
Mts/caja	78	72	64	50	48	36	32	24	24	22	18	14	12	8	
€/m	2,84	3,11	3,13	3,45	3,76	4,49	5,35	6,57	7,04	8,97	10,50	12,09	18,02	21,28	

Medida	25x15	25x18	25x22	25x25	25x28	25x35	25x42	25x48	25x54	25x64	25x76	25x90	25x114		
Mts/caja	52	50	42	40	40	24	22	18	16	12	10	8	6		
€/m	4,63	4,65	4,91	5,27	5,63	6,18	8,19	9,62	10,49	11,71	13,53	15,58	21,14		

Medida	32x18	32x22	32x28	32x35	32x42	32x48	32x54	32x64	32x76	32x90	32x102	32x114	32x140	32x160	
Mts/caja	32	32	24	22	16	14	12	10	8	8	6	6	6	6	
€/m	7,24	7,73	8,66	9,24	9,93	10,93	11,76	13,45	14,75	17,05	21,26	22,53	27,23	33,54	

VENDA AUTOADHESIVA

Medida	Rollos/caja	€/rollo
30mts x 50mm	10	40,64
15mts x 50mm	20	20,86

MANTA CAUCHO B-S3, DØ

Espesor	10 mm	13 mm	19 mm	25 mm	32 mm	40 mm
Mts/rollo	20	14	10	8	6	4
€/m	24,47	31,08	38,57	44,92	58,50	72,65

DESAGÜES BAÑERA/DUCHA



Sifónico salida orientable para bañera

	Modelo	Medida	€/ud.
	S-34	1-1/2" x 40	22,72
	S-251 autom.	1-1/2" x 40	110,39

Ducha Sifónico con tapa ciega

	Medida	S-578
	Ø 60	30,09
	Ø 90	40,09

Sumidero Sifónico con rejilla para ducha

	Modelo	Medida	€/ud.
	S-134	1-1/2" x 70	8,18

Sumidero Sifónico con lámina de tela

	Modelo	Medida	€/ud.
	S-630	Ø40 / 2x1,5	145,24

ACCESORIOS SANEAMIENTO

Racor toma desagüe electrodomésticos

	Modelo	Medida	U/caja	€/ud.
	A-1	1-1/2"	50	4,92

Te

	Modelo	Medida	U/caja	€/ud.
	A-10	1-1/2"	50	4,36

Codo para tubos lisos/boca

	Modelo	Medida	U/caja	€/ud.
	A-7	1-1/2"	50	3,08
	A-8			3,19

Enlace para tubos lisos

	Modelo	Medida	U/caja	€/ud.
	A-14	1-1/4"	50	2,38
		1-1/2"	50	3,02

Alargadera 1 boca para tubos lisos

	Modelo	Medida	U/caja	€/ud.
	A-15	1-1/4"	50	2,67
		1-1/2"	50	2,90

Enlaces mixtos macho PVC con 1 y 2 tomas

	Modelo	Medida	U/caja	€/ud.
	A-49	1-1/4"	50	3,15
		A-49D	1-1/2"	50

Cuello extensible doble toma

	Modelo	Medida	U/caja	€/ud.
	A-50	1-1/2"	50	6,55

Racor reductor con valona y tuerca loca

	Modelo	Medida	U/caja	€/ud.
	A-27	1 1/4"x40	50	2,60

Enlace mixto para instalaciones mixtas de PVC

	Modelo	Medida	U/caja	€/ud.
	A-3	1 1/2"x40	50	1,39

	Modelo	Medida	U/caja	€/ud.
	A-2	1-1/4"	50	3,36
		1-1/2"	50	4,17

SALIDAS DE W.C. JUNTA NEOPRENO

Excéntrica

	PVC	Ø	Ref.	€/ud.
		90	S-213	11,76
		110	S-213	12,88

	Modelo	Medida	U/caja	€/ud.
	A-12	1 1/2"x40	50	3,14

Concéntrica

	PVC	Ø	Ref.	€/ud.
		90	S-164	11,45
		110	S-164	11,27

SALIDAS DE W.C. FLEXIBLES

Excéntrica

	Ø	Ref.	€/ud.
	90-18	S-219	18,05
	110-16	S-219	18,05
	110-40	S-383	17,96
	110-80	T-119	8,67

Concéntrica

	Ø	Ref.	€/ud.
	90	S-218	18,05
	110	S-218	18,05

Manguito inodoro extensible

	Ø	Ref.	€/ud.
	110	25-63	32,80
		S-500	26,60

Codo W.C.

	Ø	Ref.	€/ud.
	110	CW-13	15,59

Codo doble y triple toma

	Ø	Doble	Triple
	110-45°	8,87	-
	110-87°	8,54	11,47

SIFONES SENCILLOS



Con Válvula

	Modelo	Medida	U/caja	€/ud.
	S-11	1 1/4"	50	12,26
1 1/2"		50	12,61	
	Modelo	Medida	U/caja	€/ud.
	S-84	1 1/4"	50	13,40
1 1/2"		50	14,13	
	Modelo	Medida	U/caja	€/ud.
	S-90	1 1/4"	50	13,61
1 1/2"		50	13,94	
	Modelo	Medida	U/caja	€/ud.
	S-89	1 1/4"	50	15,08
1 1/2"		50	15,80	
	Modelo	Medida	U/caja	€/ud.
	S-154	1 1/2"	50	14,85

Sin Válvula

	Modelo	Medida	U/caja	€/ud.
	S-31	1 1/4"	50	7,26
1 1/2"		50	7,43	
	Modelo	Medida	U/caja	€/ud.
	S-67	1 1/4"	50	9,03
1 1/2"		50	9,05	
	Modelo	Medida	U/caja	€/ud.
	S-73	1 1/2"	50	10,11
	Modelo	Medida	U/caja	€/ud.
	S-426	1 1/4"	50	9,17
1 1/2"		50	9,48	
	Modelo	Medida	U/caja	€/ud.
	S-305	1 1/4"	50	14,03
1 1/2"		50	14,45	
	Modelo	Medida	U/caja	€/ud.
	S-39	1 1/4"	50	7,76
1 1/2"		50	8,00	
	Modelo	Medida	U/caja	€/ud.
	S-69	1 1/4"	50	7,38
1 1/2"		50	7,68	

EXTENSIBLES

	Modelo	Medida	€/ud.
	A-103	1 1/4" x 32/40	7,94
A-104	1 1/2" x 40/50	8,86	

SIFONES DOBLES

	Modelo	Medida	U/caja	€/ud.
	S-50	1 1/2"	25	18,67

	Modelo	Medida	U/caja	€/ud.
	S-306	1 1/2"	10	27,77

VALVULAS DE DESAGÜE

	Modelo	Medida	U/caja	€/ud.
	S-35	1 1/4"	100	8,46
1 1/2"		100	8,58	
	Modelo	Medida	U/caja	€/ud.
	S-160	1 1/2"x115	50	14,99
	Modelo	Medida	U/caja	€/ud.
	S-236	1 1/2"x115	50	23,51
	Modelo	Medida	U/caja	€/ud.
	S-13	1 1/2"x70	50	6,51

	Modelo	Medida	U/caja	€/ud.
	S-51	1 1/2"x70	100	19,55
	Modelo	Medida	U/caja	€/ud.
	S-161	1 1/2"x115	25	27,09
	Modelo	Medida	U/caja	€/ud.
	S-237	1 1/2"x115	25	30,41
S-337	29,96			
	Modelo	Medida	U/caja	€/ud.
	A-39	32x63	50	9,53
40x63		50	9,68	

VALVULAS DE AIREACIÓN

	Modelo	Ø	U/caja	€/ud.
	A-69	32M	20	26,38
		40M	20	26,38
110H	5	73,89		

	Modelo	Ø	U/caja	€/ud.
	A-112	1-1/4"x32	50	7,18
1-1/2"x40		50	7,27	

INODOROS



Elia

	€/ud.
Inodoro tanque bajo 66 x 35 cm	88,00
Tanque bajo c/mecanismo de doble pulsador simple	119,50
Asiento fijo	40,50
Asiento amortiguado	64,00
Bidé	72,00



Emma BTW

	€/ud.
Inodoro tanque bajo 61,5 x 36 cm	227,00
Tanque bajo c/mecanismo de doble pulsador	153,00
Asiento fijo	68,50
Asiento amortiguado	106,00
Codo curvo s/v	17,20
Bidé	143,50
Inodoro suspendido	240,00
Bidé suspendido	196,00



Smart BTW

	€/ud.
Inodoro tanque bajo 62,5 x 39 cm	180,00
Tanque bajo c/mecanismo de doble pulsador	167,00
Asiento fijo	62,00
Asiento amortiguado	100,00
Codo curvo s/v	17,20
Bidé	141,00



Emma square BTW

	€/ud.
Inodoro tanque bajo 61,5 x 36 cm	274,00
Tanque bajo c/mecanismo de doble pulsador	153,00
Asiento fijo	73,00
Codo curvo s/v	17,20
Asiento amortiguado	130,00
Bidé	183,00



MID

	€/ud.
Inodoro tanque bajo 62,5 x 39 cm	263,00
Tanque bajo c/mecanismo de doble pulsador	117,50
Asiento fijo	55,50
Asiento amortiguado	93,50
Codo curvo s/v	17,20
Bidé	146,50



BLUE (Movilidad Reducida) 

	€/ud.
Inodoro tanque bajo 65 x 36 cm	342,00
Tanque bajo doble pulsador A/I	151,00
Asiento fijo	83,50
Codo curvo	30,40

PLATOS DE DUCHA

Silex-Stone 3mm



	Ancho			
	Largo	70	75	80
80		206,0	221,0	236,0
90		224,0	239,0	254,0
100		241,0	259,0	276,0
120		264,0	281,0	299,0
140		301,0	321,0	341,0
160		334,0	356,0	379,0
180		374,0	399,0	426,0

SISTEMAS EMPOTRADOS OLI



Medidas	€/ud.
Soporte - Cisterna Empotrada 120	292,65
Soporte - Cisterna Empotrada 90	308,70
Soporte Bidé	278,69
Pulsador CROMO	77,59
Pulsador NEGRO	108,19
Pulsador BLANCO	52,09

Consultar precio para otras medidas
Disponible en diferentes texturas y colores

CANALON Y ACCESORIOS CIRCULAR

Canalón en tramos de 3 m.

Desarrollo	€/ml.
25	7,67
33	15,80

Unión

Desarrollo	€/ud.
25	8,85
33	12,60

Bajada Central

Desarrollo	€/ud.
25 ø 90	12,90
33 ø 110	19,29

Bajada Dcha. e Izquierda

Desarrollo/Salida	€/ud.
25 ø 90	12,05
33 ø 110	17,93

Tapa Universal

Desarrollo	€/ud.
25	1,95
33	4,20

Angulo Exterior

Desarrollo	€/ud.
25	13,20
33	19,67

Angulo Interior

Desarrollo	€/ud.
25	13,80
33	24,48

Gancho Soporte Galvanizado

Desarrollo	€/ud.
25	4,55
33	5,23

Gancho colocación sobre Banda Vertical

Desarrollo	€/ud.
25	2,85
33	3,36

Pletina Cubierta Ondulada

Desarrollo	€/ud.
Uralita	2,95
Teja	3,10

Pletina recta y 45°

Desarrollo	€/ud.
Recta-Curva	2,01
Curvada-Larga	2,66

Parahojas Universal

	€/ud.
	2,43

CANALON METALICO



CANALON



Medida	Cobre	Prelacado
28 x 0,6 mm €/ml.	45,55	9,26
33 x 0,6 mm €/ml.	53,48	11,00

INGLETE EXTERIOR-INTERIOR

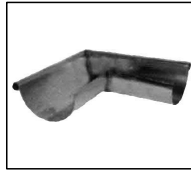

Medida	Cobre	Prelacado
28 €/und.	66,96	29,17
33 €/und.	71,60	29,78

TAPA DE PEGAR



Medida	Cobre	Prelacado
28 €/und.	9,19	3,67
33 €/und.	9,57	3,87

PALOMILLA CORTA ENCAJE / DOBLE LENGÜETA



Medida	Cobre	Prelacado	Prelacado
28 x 30 x 4 €/und.	14,14	5,09	5,21
33 x 30 x 5 €/und.	19,55	5,64	5,85

PALOMILLA LARGA



Medida	Cobre	Prelacado
28 x 30 x 4 €/und.	12,01	4,64
33 x 30 x 5 €/und.	13,07	4,81

BAJANTE REDONDA (Tubos de 3 m.)



Medida	Cobre	Prelacado
80 x 0,6 €/ml.	47,74	9,83
100 x 0,6 €/ml.	58,26	11,34

BAJANTE REDONDA (Tubos 1 m.)

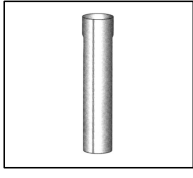

Medida	Cobre	Prelacado
80 x 0,6 €/ml.	52,84	11,21
100 x 0,6 €/ml.	59,41	13,38

Precio por ml ó ud.

CODO DOBLE

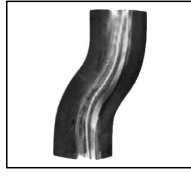

Medida	Cobre	Prelacado
80 €/und.	59,99	25,25
100 €/und.	65,96	29,28

CODO SOLDADO



Medida	Cobre	Prelacado
100 - 72° €/ud.	17,05	5,72
80 - 72° €/ud.	14,92	4,70
100 - 45° €/ud.	20,76	5,83
80 - 45° €/ud.	16,84	5,63

MANGUITO CONEXION BAJANTE, MACHO-HEMBRA



Medida	Cobre	Prelacado
80 €/und.	15,89	7,37
100 €/und.	20,33	8,44

BAJANTE UNIVERSAL



Medida	Cobre	Prelacado
28/80 €/ud.	24,97	10,60
28/100 €/ud.	25,13	10,77
33/100 €/ud.	25,58	11,02

DERIVACION

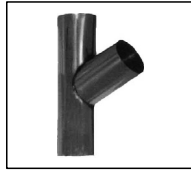

Medida	Cobre	Prelacado
80 €/und.	63,77	29,09
100 €/und.	69,11	32,54

CUBETA RECOGIDA CUADRADA

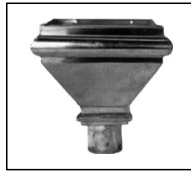

	Cobre	Prelacado
80 Euros/und.	279,42	217,54
100 Euros/und.	279,42	217,54

ABRAZADERA



Medida	Cobre	Prelacado
80 €/ud.	7,06	2,62
100 €/ud.	7,26	2,65

REDUCCION



Reducción 100/80	
Cobre	49,34
Prelacado	23,42

PROTECTOR FUNDIDO



Medida	Precio
1,7 m. €/ud.	164

MASILLA POLIURETANO

Peso	Precio
300 ml.	9,87

BOMBAS SUMERGIBLES



Pumpen Intelligenz.



AGUAS SUCIAS/DRENAJE
Serie Wilo Drain TM/TMW (1-230V)

*A con interruptor de flotador

Bomba sumergible para aguas grises domésticas

Modelo	Rosca	Potencia KW	€/ud.
TM 32/7 A	1 1/4"	0,25	323,00
TMW 32/11 A	1 1/4"	0,55	476,00
Initial Waste 16-11	1 1/2"	1,10	276,00
Initial Waste 14-9	1 1/2"	0,90	249,00



AGUAS RESIDUALES
Serie Wilo REXA MINI3-V04-11

Bomba sumergible para aguas residuales. Paso de sólidos 40 mm.

Modelo	Rosca	Potencia KW	€/ud.
Rexa Mini V04-11	1 1/2"	0,60	666,00



ACCESORIOS

Dispositivo Hidráulico-electrónico con protección contra marcha en seco y válvula antirretorno.

Nota: Bomba+Fluid+Racores=Grupo de Presión

Modelo	€/ud.
HI-CONTROL CON CABLE	201,00

GRUPOS DE PRESION

Serie Wilo MEDANACH1-LC



Bomba centrífuga horizontal multietapas, de aspiración normal. Temperatura del fluido: max. 90°C
Presión de trabajo: máx. 10 bar.

Modelo	R. Asp - R. Imp.	Potencia KW	€/ud.
Medana 602-5	1 1/4" - 1"	0,55	738,00
Medana 603-5	1 1/4" - 1"	0,75	738,00
Medana 604-5	1 1/4" - 1"	1,1	766,00
Jet WJ204X	1 1/4" - 1"	1	400,00

RACORES



Medida	€/ud.
1/2" x 1"	23,00
1" x 1 1/2"	22,00
1 1/4" x 2"	25,00

BOMBAS CALEFACCIÓN Y CLIMATIZACIÓN ALTA EFICIENCIA



Rango de temp. De 2°C a 110°C

Modelo	Longitud	Rosca	€/ud.
Yonos Pico 1.0 25/1-4	130	1"	380,00
Yonos Pico 1.0 25/1-6	130/180	1"	417,00
Yonos Pico 1.0 25/1-8	180	1"	638,00
Yonos Pico 1.0 30/1-8	180	1"	638,00



Rango de temp. De 2°C a 110°C

Modelo	Longitud	Rosca	€/ud.
Yonos Maxo Z25/0,5-10	180	1 1/2"	2.116,00
Yonos Maxo Z30/0,5-12	180	2"	2.430,00
Yonos Maxo 25/0,5-7	180	1 1/2"	1.207,00
Yonos Maxo 25/0,5-10	180	1 1/2"	1.321,00
Yonos Maxo 30/0,5-10	180	2"	1.427,00
Yonos Maxo 40/0,5-8	220	DN 40	2.165,00
Yonos Maxo 40/0,5-12	250	DN 40	2.564,00
Yonos Maxo 50/0,5-12	280	DN 50	3.380,00

OTRAS BOMBAS Y GRUPOS DE PRESIÓN OPCIONALES



BOMBAS TWU

Bombas de 4,6,8 y 10"
Profundidades desde 200 a 350 m.
Altura max. 320-350 mts.



COR 2 MHIE

Grupo de presión provisto de 2 a 4 bombas multietapas
Presión max 10 bar



BOMBAS IPL

Bomba de rotor seco
Temp de -10°C a 120°C
Conexión desde DN25 a DN100
Presión max. 10 bar

MATERIAL PARA RIEGO



POR ASPERSION

Arquetas PP rectangular

	Medida	€/ud.
	50x37x30	41,49
	63x48x30	66,26

Arquetas PP circular

	Medida	€/ud.
	Ø20 16x24	8,30
	Ø33 24x25	17,10

Hidrante

	Medida	€/ud.
	3/4" H	30,65
	1"H	48,47

Bobinas recortables

	Medida	€/ud.
	1/2" x 1/2"	0,35
	3/4" x 1/2"	0,35
	3/4" x 3/4"	0,35

Difusor emergente con tobera regulable

	Medida	€/ud.
	uni-spray 415	4,25
	1804-15van	3,98

Bayoneta

Codo Loco

	Medida	€/ud.	Medida	€/ud.
	3/4"	13,60	3/4"	14,26
	1"	21,60	1"	22,64

Aspersor de latón sectorial

	Medida	€/ud.
	1/2" macho	18,17
	Pincho	8,91

Aspersor de turbina

	Mod.	Medida	€/ud.
	3504	1/2"	17,43
	5004	3/4"	19,13
	5004+	3/4" PLUS	23,55
	6504	1"	83,43
	8005	1"	140,55

Sensor de lluvia

	Medida	€/ud.
	WRS inalámbrico	53,03
	RSDBEX	187,83

Programador Grifo-pilas

	Modelo	€/ud.
	Electrónico	72,81

Emergente con aspersor

	Medida	€/ud.
	3/4" Hembra	40,63
	Maxi-paw	52,89



RZX



ESP-9 V



WOOBEE

Programadores

Modelo	1 est.	2 est.	4 est.	6 est.	8 est.
RZX	-	-	125,18	143,97	166,81
WPX-9 V	119,39	205,66	224,44	253,31	-
WOOBEE	119,25	186,29	203,33	229,50	-
RC2 con WIFI INCORPORADO	-	-	138,47	154,57	-

Filtro y cartucho

	Artículo	€/ud.
	repuesto cartucho	BO BO
		5,00 12,00
filtro agua sin cartucho	22,00	

Electroválvulas

	Mod.	Artículo	24 V	9 V
	100 DV	PP+FV1"	39,21	61,18
	150 PGA	PP+FV1 1/2"	97,88	138,83
	200 PGA	PP+FV2"	137,70	173,26
	100 HV	1" sin control de caudal	24,32	-

Regulador Presión + Filtro

	Modelo	€/ud.
	3/4"	27,48
	1"	30,16

Solenoide

	Artículo	€/ud.
	24 v DV JTV	26,12
	24 v PGA	71,06
	9 v	50,01

Filtro malla con purga

	Artículo	€/ud.
	3/4"-1"	12,07
	1 1/4"	18,38
	1 1/2"	20,32
	2"	31,94

MATERIAL PARA RIEGO

POR GOTEO

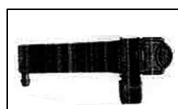

Gotero pinchado desmontable

Modelo	Caudal	€/ud.
X-20	4,0 l/h	0,94



Microaspersor

Modelo	Caudal	€/ud.
X-47	4,0 l/h	4,32



Gotero pinchado desmontable

Modelo	Caudal	€/ud.
X-36	4,0 l/h	0,17



Gotero pinchado autocompensante

Modelo	Caudal	€/ud.
X-18	4,0 l/h	1,29
Rain Bird	4,0 l/h	0,35



Estaca Rain-bird

Modelo	Caudal	€/ud.
		0,47



Gotero para macetas

Modelo	Caudal	€/ud.
X-21	1,2 l/h	1,65



Perforador

Modelo		€/ud.
X-28		7,60

TUBERIA

GOTEO



Modelo	€/ml	
Polietileno Ø 16 mm	0,27	
Marrón c/goteros auto cada 33 cm	0,75	
Microtubo Ø 6'5x4'5 mm	Cubo	Rollo 25mts
	195,00	10,80
SPX-FLEX	48,80	

ACCESORIOS



Te

Modelo	Ø	€/ud.
X-3	16	0,28
Mixta	1/2"y3/4"	0,44



Manguito

Modelo	Ø	€/ud.
X-5	16	0,24



Tapón final

Modelo	Ø	€/ud.
X-8	16	0,12



Enlace mixto rosca macho

Modelo	Ø	€/ud.
X-10	16-1/2"	0,37



Válvula de cierre

Modelo	Ø	€/ud.
CEPEX	16	0,93
X-34	Mixta	4,03



Enlace mixto rosca hembra

Modelo	Ø	€/ud.
X-9	16-1/2"	0,79



Junta Bilabial

Modelo	Ø	€/ud.
X-38		0,40

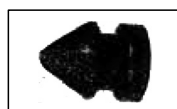

Tapón Gotero

Modelo	Ø	€/ud.
X-27	16	0,08



Codo 90°

Modelo	Ø	€/ud.
X-12	16	0,45



Codo 90° rosca macho

Modelo	Ø	€/ud.
X-3	16-1/2"	0,57
	16-3/4"	0,57



Derivación te microtubo

Modelo	Ø	€/ud.
X-42	6,5x4,5	0,29



Toma microtubo

Modelo	Ø	€/ud.
X-26	6,5x4,5	0,17



Toma injerto

Modelo	Ø	€/ud.
X-7	16	0,12

MATERIAL PARA RIEGO

Mangueras jardinería

	Medida	€/mts.
	12x16 cristal	1,08
	15x20 cristal	1,62
	15x20 verde	1,48
	19x25 verde	2,13
	25x32 verde	3,69

Manguera aspiración e impulsión kanal-A

	Ø INT.	€/mts.
	20	5,30
	25	6,50
	30	7,30
	35	8,82
	40	9,55
	45	11,21
	50	13,50
	60	15,82

Manguera plana azul

	Ø INT.	€/mts.
	45L 4 bares	6,43
	63L 4 bares	8,78

ACCESORIOS MANGUERAS

	Adaptador rosca H	
	Rosca	€/ud.
	1/2"	2,14
	3/4"	2,08
	1"	2,21
	M 3/4"	2,08

	Lanza riego acople rápido	
		€/ud.
	Plástico	5,67

	Conector rápido	
	Rosca	€/ud.
	1/2"	3,72
	3/4"	5,10
	5/8"	4,66

	Pistola de precisión	
		€/ud.
	Precisión	10,40
	Difusora	15,88

	Reparador Manguera	
	Rosca	€/ud.
	1/2"	2,96
	3/4"	4,60

	Conector dos Vías	
		€/ud.
	2 vías	2,58
	3 vías	4,46

ACCESORIOS

PARA COLECTORES

	1" Te M/H/H con junta	
	Modelo	€/ud.
	X-103	7,59

	1" Tapón hembra con junta	
	Modelo	€/ud.
	X-105	2,83

	1" Macho con junta	
	Modelo	€/ud.
	X-104	3,59

	1" Codo con junta M/H	
	Modelo	€/ud.
	X-106	6,63

TAPAS Y REJILLAS

DE FUNDICION DÚCTIL

Tapas cuadradas clase B-125

Alumbrado, anónima, agua potable, saneamiento



Medida	€/ud.
30 x 30	15,40
40 x 40	29,90
50 x 50	48,90
60 x 60	79,60
70 x 70	159,10
80 x 80	191,30
90 x 90	303,40
100 x 100	433,40

Tapas cuadradas clase



	C-250	D-400	Relleable C-250
Medida	€/ud.	€/ud.	€/ud.
40 x 40	60,50	83,20	114,10
50 x 50	91,80	122,50	172,80
60 x 60	140,70	189,60	233,20
70 x 70	168,90	221,80	321,20
80 x 80	216,60	283,20	-
90 x 90	320,10	392,10	-
100x100	-	525,80	-

Tapas IBERDROLA



Modelo	M2T2 B-125	M3T3 D-400
Medida	70x70	Ø 600
€/ud.	191,20	228,90

Sumideros y tragantes



Modelo	€/ud.
tempo 500T	520,30
tempo plus	1.204,00

Registros Circulares



Medida	€/ud.
Geo Ø600 D-400	273,20
Ø600 (ext ø850) D-400	164,20
Ø550 (ext ø730) D-400	121,90
Ø580 (ext ø670) C-250	81,20

Tapas boca de riego y agua potable

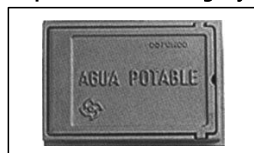

Medida	€/ud.
22 x 14	22,40

Pozo sifónico polietileno



Medida	€/ud.
420x210x500	46,25
500x500x600 Tipo Burgos	95,70

Rejilla sumidero con marco



	Medida	€/ud.
ABATIBLE CIRCULAR	Ø 600	194,70
AYUNTAMIENTO	50 x 30 x 4	89,70
REJA NORTE	50 x 26 x 4,5	78,80
ESLA - PORTOFINO C-250	46 x 23 x 3,5	39,70
REJA CONCAVA	50 x 30 x 4 C-250	53,80
REJA PLANA C-250	30 x 30 (36 x 36) ext.	52,60
REJA PLANA C-250	40 x 40 (46 x 46) ext.	61,05
REJA PLANA C-250	50 x 50 (56 x 56) ext.	91,80
NERVION D-400	42 x 32 x 70	75,90
PORTOFINO N-D-400	70 x 40 D-400	91,60

Marco y Tapa telecomunicaciones

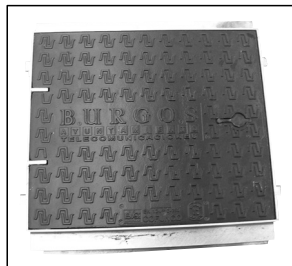

	Medida	€/ud.
Tapa telecomunicaciones Ayto. Burgos	60x60 B-125	419,10
Tapa telefónica tipo M	40x40 clase B-125	29,90
Tapa telefónica tipo H de Hormigón	B-125 homologada	619,50
Tapa telefónica tipo D hormigón homologada		1.241,80
Tapa telecomunicaciones tipo H	80x70 B-125	305,30

Disponemos de todo tipo de mobiliario urbano
(bancos, fuentes, bolardos, farolas)
y parques infantiles



Estanca

Tapas Acero Galvanizado Estanca

Medida H:5	Reversible Peatonal	Lisa/Rellenable Reforzada
30 x 30	83,28	116,60
40 x 40	104,84	159,36
50 x 50	141,90	237,45
60 x 60	156,95	267,12
70 x 70	218,16	377,06



Modelo Standard aisi 304

Estanca

Tapas Acero Inoxidable Estanca

Medida	Reversible Peatonal	Lisa/Rellenable Reforzada
30 x 30	180,45	256,90
40 x 40	252,86	359,15
50 x 50	305,70	470,90
60 x 60	354,14	558,00
70 x 70	480,00	746,00



Pate polipropileno 250x350x250

€/ud.
5,30

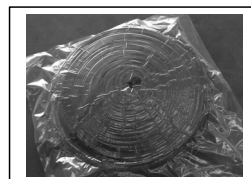

Rollo de Junta Bentonita Expansiva de 20x10. Rollos 10 m.

€/ud.
58,90

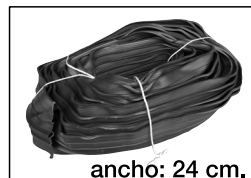

Junta PVC estanqueidad c/bulbo rollo 25 mts.

€/ud.
388,69



Lámina Drenante	Medida	€/m2
Con geotextil	2,1 x 15 ml.	5,40
Sin geotextil	2,1 x 28 ml.	3,10

POZOS REGISTRO SANECOR DN-1000 SN8
Con Troncocono de PEAD y pates

Altura	Con BASE	SIN BASE
1,5	1.334,88	922,11
2	1.541,16	1.128,16
2,5	1.770,11	1.357,37
3	2.023,24	1.610,16
3,5	2.267,64	1.854,86
4	2.507,62	2.094,84
4,5	2.735,07	2.322,31
5	3.002,55	2.589,70
5,5	3.220,37	2.808,00
6	3.452,46	3.039,67

GEOTEXTIL NO TEJIDO POLIPROPILENO

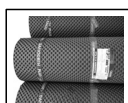

Geotexan
geosintéticos de alta calidad

Gramaje gr/m2	Resistencia a la tracción Kn/m	Formato	€/m2
NT 12 100	8	2,75 x 100m	0,99
NT 175 150	12	2,75 x 100m	1,45
NT 23 200	16	2,75 x 100m	1,97



Envase 25 kg.	€/ud.
	24,50

Aglomerado en frío

Envase 25 kg.	€/ud.
	79,40

Emulsión Asfáltica Curidan

PREFABRICADOS DE HORMIGÓN

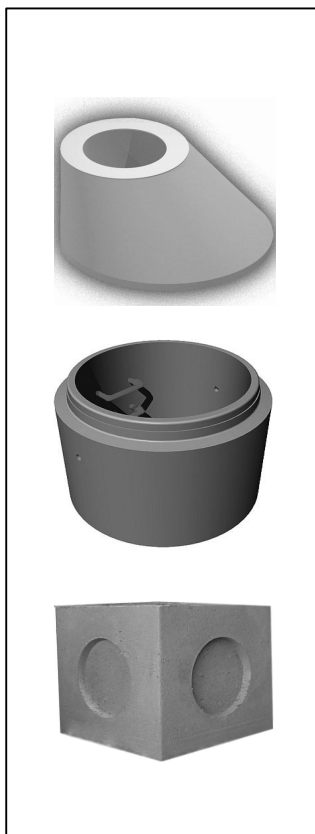

características	€/ud.
Arqueta 30 x 30 con fondo	26,73
Arqueta 35 x 35 con fondo	28,05
Arqueta 40 x 40 con fondo	23,35
Arqueta 50 x 50 con fondo	38,97
Arqueta 60 x 60 con fondo	52,34
Arqueta 70 x 70 con fondo	119,18
Arqueta 80 x 80 con fondo	150,75
Arqueta 100 x 100 con fondo	243,65
Arqueta 30 x 30 sin fondo	25,48
Arqueta 35 x 35 sin fondo	24,15
Arqueta 40 x 40 sin fondo	21,58
Arqueta 50 x 50 sin fondo	34,74
Arqueta 60 x 60 sin fondo	46,62
Arqueta 70 x 70 sin fondo	107,43
Arqueta 80 x 80 sin fondo	132,86
Arqueta 100 x 100 sin fondo	213,49
Arqueta Iberdrola 1000 x 600 H=1000	195,00
Arqueta tipo D Telefónica Homologada	1.099,80
Tapa tipo D Telefónica Homologada	1.537,33
Arqueta tipo H Telefónica Homologada	787,80
Tapa tipo H Telefónica Homologada	765,67

características	€/ud.
Tapa hormigón 30 x 30	22,78
Tapa hormigón 40 x 40	26,88
Tapa hormigón 50 x 50	38,43
Tapa hormigón 60 x 60	58,45
Tapa hormigón 70 x 70	78,73
Embocadura recta 400	61,05
Embocadura recta 500 y 600	103,43
Embocadura abierta 500 y 600	262,63
Tubo 400 L = 1 mt.	33,75
Tubo 500 L = 1 mt.	50,93
Tubo 600 L = 1 mt.	69,26
Tubo 800 L = 1 mt.	84,73
Tubo 1.000 L = 1,1 mt.	113,93
Cono de Hormigón 600 x 1000 H=700	84,50
Aro de Hormigón 1000 x 1000 x 1000	127,53
Aro de Hormigón 1000 x 1000 x 500	73,24
Aro de Hormigón 1000 x 1000 x 300	74,59
Sumidero Sifónico Tipo Burgos 60 x 60	116,64
Sumidero Sifónico 46 x 26 x 50	46,67

ACCESORIOS SUELO

Arquetas cúbicas de PVC

Medida	€/ud. arqueta	€/ud. tapa
200	4,71	3,63
300	9,33	8,52
400	18,70	16,29
550	40,43	51,96

Placa sífónica

Medida	€/ud.
200x200	3,95
300x300	4,80
400x400	6,87
550x550	15,33

Tapa c/marco PVC peatonal

Medida	€/ud.
20x20	6,11
30x30	11,95
40x40	20,84

Arquetas HDPE aislada para contador

Polietileno (38x21x27)	€/ud.
* completa 3/4" c/válvula de corte, retención y cont.	215,40
sin contador	156,95

Canal hormigón polímero ACO

Modelo	Clase de Carga	Medida (A x h x L)	€/ud.
Hexaline reja PP	A-15	129 x 81 x 1000	18,70
SELF 100 reja Galva	A-15	118 x 99 x 1000	31,10
SELF 200 reja fundición	B-125	200 x 150 x 1000	86,80
V-100BA reja fundición	C-250	135 x 80 x 1000	93,40
V-100 reja fundición	C-250	135 x 150 x 1000	92,70
V-150 reja fundición	C-250	185 x 210 x 1000	131,80
V-150 reja fundición	D-400	185 x 210 x 1000	142,90
V-200 reja fundición	D-400	235 x 265 x 1000	197,10
PD-100V reja fundición	D-400	150 x 230 x 1000	97,80
MONOBLOCK RD 150V	F-900	210 x 280 x 1000	182,10
MONOBLOCK RD 200V	F-900	260 x 330 x 1000	219,90

Disponemos de más medidas bajo pedido

Armarios y Puertas de poliéster y PP para contador

Armario	Medida	Aislado	Pta. aislada
	25 x 35	59,09	53,64
	30 x 45	60,93	57,71

Puerta	Medida	Poliéster
	25 x 35	40,04
	30 x 45	42,06

Hidrante de superficie c/carcasa

UNE 23405	IZARO	IZARO-S
Medida	€/ud.	€/ud.
DN80 (2x45 + 1x70)	1.641,49	1.393,67
DN100 (2x70 + 1x100)	1.852,99	1.612,50

Hidrante enterrado UNE 23407

DN (n.º salidas)	c/arqueta
DN 100 AENOR (2x70 mm.)	701,69
DN 100 AENOR (1x70 + 1x45)	701,69
Tipo Ayto. de Burgos (1x70 mm.+1x45)	854,83

Bocas de riego con caja	Boca de riego rosca tipo Burgos	
BRI-45 DN 40 racor Barcelona	con caja	sin caja
€/ud.	164,75	187,40 156,20

Adaptadores rosca Burgos	€/ud.
Adaptador Burgos macho	19,03
Adaptador Burgos hembra	37,62

Boca de Incendios equipadas (BIE)

	Consultar
--	------------------

Racor aluminio

DN	MACHO	HEMBRA	DN	€/ud.	DN	€/ud.
25-R-1"	19,38	19,31	25	46,33	45-25	40,72
45-R-11/2"	28,54	29,96	45	57,20	70-45	84,89
70-R-21/2"	38,98	41,06	70	108,70		

FOSAS SEPTICAS

CON FILTRO BIOLÓGICO



EPURBLOC

Modelo	volumen	L x A x H	€/ud.
Epubloc 77 1500	1.500 lts	1,70 x 0,77 x 1,66	1.116,36
Epubloc 119 2000	2.000 lts	1,90 x 1,19 x 1,44	1.354,50
Epubloc 119 3000	3.000 lts	2,70 x 1,19 x 1,44	1.848,42
Epubloc 185 4000	4.000 lts	2,05 x 1,85 x 1,55	2.143,26
Epubloc 185 5000	5.000 lts	2,43 x 1,85 x 1,55	2.456,24
Epubloc 185 8000	8.000 lts	4,20 x 1,85 x 1,55	4.708,62
Epubloc 185 9000	9.000 lts	4,58 x 1,85 x 1,55	5.279,90
Epubloc 185 10.000	10.000 lts	4,97 x 1,85 x 1,55	5.960,30

SEPARADORES HIDROCARBUROS PE



CON FILTRO Y DECANTADOR

Modelo	caudal	L x A x H	€/ud.
YH0501E	1,5 l/seg	1,00 x 1,00 x 1,00	1.690
YH0503E	3 l/seg	1,20 x 1,20 x 1,23	1.840
YH0506E	6 l/seg	1,50 x 1,50 x 1,70	2.596

SEPARADOR DE GRASAS PE



SEPARADOR DE GRASAS PE

Modelo	caudal	L x A x H	€/ud.
SG200	0,5 l/seg	1,20 x 0,60 x 0,65	422,10
SG500	1 l/seg	1,70 x 0,77 x 0,73	612,36
SG1000	3 l/seg	1,70 x 0,77 x 1,23	707,57
SG2500	6 l/seg	1,90 x 1,19 x 1,57	1.646,82
SG3500	9 l/seg	2,70 x 1,19 x 1,57	2.300,00

OTRAS OPCIONES EN PRFV

- SEPARADORES DE GRASAS
- SEPARADORES DE FÉCULAS
- FOSAS SÉPTICAS
- SEPARADORES HIDROCARBUROS CLASE I



DEPOSITOS DE GASOLEO CON MARCADO CE



Eurolentz

CAPACIDAD	LONGITUD	ANCHURA	ALTURA	€/ud.
500 litros	780 mm	780 mm	1.100 mm	268,46
700 litros	1.190 mm	660 mm	1.240 mm	284,89
1.000 litros	1.650 mm	720 mm	1.260 mm	364,85
1.500 litros	1.650 mm	720 mm	1.750 mm	528,33
2.000 litros	2.180 mm	720 mm	1.780 mm	716,14
2.500 litros	2.170 mm	890 mm	1.730 mm	1.148,12

Variolentz

CAPACIDAD	LONGITUD	ANCHURA	ALTURA	€/ud.
700 litros	780 mm	780 mm	1.490 mm	318,44
1.000 litros	780 mm	780 mm	2.000 mm	389,85

DEPOSITOS DOBLE PARED P.E.



CAPACIDAD	LONGITUD	ANCHURA	ALTURA	€/ud.
700 litros	1.280 mm	690 mm	1.260 mm	666,16
1.000 litros	1.740 mm	750 mm	1.310 mm	729,00
1.500 litros	1.740 mm	750 mm	1.765 mm	1.026,73
2.000 litros	2.290 mm	780 mm	1.810 mm	1.516,54

Tanques gasóleo con cubeto incorporado verde.

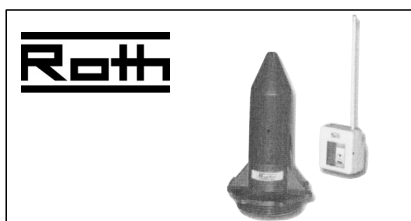

INDICADOR DE NIVEL ELECTRONICO ROTHALERT

Adaptable a cualquier tipo de depósito Altura de medida hasta 3 mts. No apto para gasolina ni líquidos corrosivos Alcance máximo 200 mts.	€/ud.
	234,40



BANDEJAS

CAPACIDAD	MEDIDAS	€/ud.
500/700 litros	990 x 930 x 150 mm	119,24
1.000 litros	1.850 x 860 x 150 mm	127,09

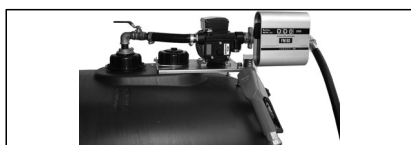

EQUIPOS TRASIEGO

Con contador	56 l/m. boquerel automático	774,00 €/ud.
Sin contador	56 l/m. boquerel automático	583,00 €/ud.

DEPOSITOS AGUA POTABLE



MODULAR - GAMA AQUAVARIO

CAPACIDAD	Longitud	Anchura	Altura	€/ud.
500 litros	0,78 mm	0,78 mm	1,10 m	353,81
750 litros	0,78 mm	0,78 mm	0,149 m	399,67
1.000 litros	0,78 mm	0,78 mm	2,0 m	440,08



DEPÓSITOS AQUALENTZ RECTANGULARES ATM

MODELO	CAPACIDAD	Peso	Largo x Ancho x Alto	€/ud.
Rectangular ATM 1000	1.000 l	47 kg	1,16 x 0,73 x 1,67 m	504,51
Rectangular ATM 2000	2.000 l	82 kg	1,64 x 0,88 x 1,80 m	880,15
Rectangular ATM 3000	3.000 l	114 kg	2,35 x 0,88 x 1,80 m	1.184,32
AQUALENZ 66 700	700 l	27 kg	1,19 x 0,66 x 1,24 m	419,33
AQUALENZ 66 1000	1.000 l	39 kg	1,19 x 0,66 x 1,81 m	521,97

MAQUINAS DE ALQUILER



**Máquina de Soldar
Accesorios Electrosoldables**
Manual y scanner



**Pinza para manipulación
de prefabricados**
Pinza triple con cadenas, hasta 3.000 kgs.

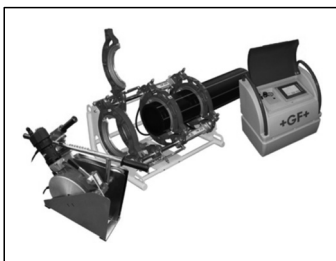

Máquina de Soldar a Tope
De diámetro
90 - 110 - 125 - 140 - 160
180 - 200 - 225 - 250 - 315 mm



**Balón obturador
para pruebas de presión**
Balón Ciego + Balón con by pass
de 150 a 400mm. Manguera de inflado,
Válvula de seguridad y manómetro.
Presión de inflado de balón: 1 bar.



Pinzador
Para tuberías desde 20mm a 63mm

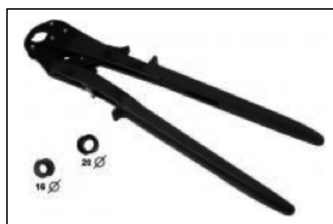

**Máquina Press Fitting
y Multicapa Manual**
Diámetros 16-18-20 mm



Rascador PT-2
- Diámetros desde 63mm a 250mm
- Diámetros desde 180mm a 630mm



**Máquina Press Fitting para PE-X
y Multicapa Automática**
Diámetros 16-18-20-25 mm

BRIDAS

- Dimensiones de las bridas
- Cantidad y medidas de los tornillos (normas DIN)

- A: Diámetro exterior
- B: Distancia entre centros de taladros
- C: Diámetro de los taladros

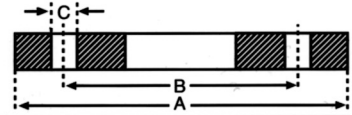

DN	BRIDAS			TORNILLOS	
	A	B	C	Cant.	Rosca M
40	150	110	19	4	16
50	165	125	19	4	16
60	175	135	19	4	16
65	185	145	19	4	16
80	200	160	19	8	16
100	220	180	19	8	16
125	250	210	19	8	16
150	285	240	23	8	20
175	315	270	23	8	20
200	340	295	23	8	20
250	395	350	23	12	20
300	445	400	23	12	20
350	505	460	23	16	20
400	565	515	28	16	24
450	615	565	28	20	24
500	670	620	28	20	24
600	780	725	31	20	27
700	895	840	31	24	27
800	1015	950	34	24	30
900	1115	1050	34	28	30
1000	1230	1160	37	28	33

DN	BRIDAS			TORNILLOS	
	A	B	C	Cant.	Rosca M
40	150	110	19	4	16
50	165	125	19	4	16
60	175	135	19	4	16
65	185	145	19	4	16
80	200	160	19	8	16
100	220	180	19	8	16
125	250	210	19	8	16
150	285	240	23	8	20
200	340	295	23	12	20
250	405	355	28	12	24
300	460	410	28	12	24
350	520	470	28	16	24
400	580	525	31	16	27
450	640	585	31	20	27
500	715	650	34	20	30
600	840	770	37	20	33
700	910	840	37	24	33
800	1025	950	40	24	36
900	1125	1050	40	28	36
1000	1255	1170	43	28	39

DN	BRIDAS			TORNILLOS	
	A	B	C	Cant.	Rosca M
40	150	110	19	4	16
50	165	125	19	4	16
60	175	135	19	8	16
65	185	145	19	8	16
80	200	160	19	8	16
100	235	190	23	8	20
125	270	220	28	8	24
150	300	250	28	8	24
200	360	310	28	12	27
250	425	370	31	12	30
300	485	430	31	16	30
350	555	490	34	16	30
400	620	550	37	16	33
450	670	600	37	20	33
500	730	660	37	20	33
600	845	770	40	20	36
700	960	875	43	24	39
800	1085	990	49	24	45
900	1185	1090	49	28	45
1000	1320	1210	56	28	52

Diámetros exteriores de los tubos utilizados en conducciones de agua

DN	Clases de tuberías:			
	PVC-PE	FIBROCEMENTO	ACERO	FUNDICIÓN GS
mm. pulg.	ø ext.	Clase	ø ext.	ø ext.
40	1 1/2	50		
50	2	63		60,3
60	2 1/2		A-F	77
65	2 1/2	75		76,1/73
80	3	90	A-F	101
100	4	110	AD	119
125	5	125	AD	149
150	6	160	AD	170
175	7	180	EF	193,7
200	8	200	AC	222
250	10	250	D	232
		280	EF	249
			AB	272
			C	280
			D	287
			EF	311

300	12	315	AB	326	323,9	326
			C	330		
			D	339		
			EF	360		
350	14	355	AB	380	355,6	378
			C	385		
			D	395		
			EF	420		
400	16	400	AB	434	406,4	429
			C	440		
			D	452		
			EF	480		
450	18	450	AB	488	457,2	480
			C	494		
			D	508		
			EF	540		
500	20	500	AB	543	508	532
		560	C	549		
			D	564		
			EF	600		
600	24	630	AB	651	608,6	635
			C	659		
			D	677		
			E	705		
			F	720		

700	28	710	AB	760	711,2	738
			C	769		
			D	790		
			E	822		
			F	840		
800	32	800	AB	868	812,8	842
			C	879		
			D	903		
			E	940		
			F	960		
900	36	900	AB	978	914,4	945
			C	989		
			D	1015		
			E	1057		
			F	1080		
1000	40	1000	AB	1086	1016	1048
			C	1100		
			D	1128		
			E	1174		
			F	1200		

REJAS Y TAPAS



Clase A 15

Carga de prueba 15 kN – 1'5 t.
Para zonas verdes, caminos peatonales o con paso de bicicletas.



Clase B 125

Carga de prueba 125 kN – 12'5 t.
Para aceras o superficies comparables, zonas de aparcamiento accesibles únicamente a turismos.



Clase C 250

Carga de prueba 250 kN – 25 t.
Para laterales de calles o carreteras, zonas de aparcamiento para vehículos ≤ 3.5 t.



Clase D 400

Carga de prueba 400 kN – 40 t.
Para zonas de acceso a vías rápidas, drenajes en calles y carreteras, y zonas de aparcamiento para todo tipo de vehículos.



Clase E 600

Carga de prueba 600 kN – 60 t.
Para zonas de trabajo de carretillas elevadoras, áreas industriales y similares.



Clase F 900

Carga de prueba 900 kN – 90 t.
Para zonas de altas cargas, como aeropuertos, zonas portuarias o similares.

Tubería evacuación
Tubería presión
Tubería saneamiento
Tubería fundición
Tubería drenaje
Tubería canalización eléctrica
Tubería polietileno BD y AD

Accesorios de evacuación
Accesorios de gran evacuación
Accesorios de presión

Canalón PVC y metálico

Accesorios fitting para PE
Accesorios latón para PE
Accesorios electrosoldables

Accesorios línea suelo

Sifones

Accesorios fundición
Tapas y rejillas de fundición
Prefabricados de hormigón
Material para riego

Bombas

Tubos y racores polietileno
Tubos y racores multicapa

Fosas sépticas

Depósitos gasoil



GOZALO